

EAN:3276007662375
Ref:HT-CLASS A

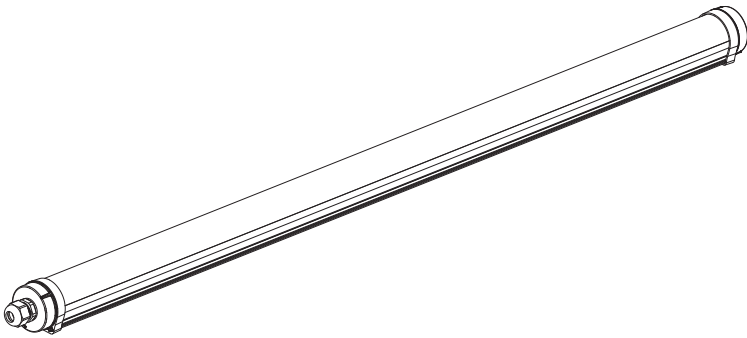

2/2



2023-06-V01

FR Manuel d'Instructions

EL Εγχειρίδιο Οδηγίων

BR Manual de Instrução

ES Manual de Instrucciones

PL Instrukcja Obsługi

DE Anleitung Handbuch

PT Manual de Instruções

UA Інструкція з Експлуатації

EN Instructions Manual

IT Manuale di Istruzioni

RO Manual de Instrucțiuni

*Année de garantie / años de garantía / Ano de garantia / Anno di garanzia / Έτος εγγύησης / Rok gwarancji / Гарантіяроків / Anul de garanție / Anos de garantía / Jahr der Garantie / Year of guarantee

** réparable / reparabile / reparável / riparabile / διορθώσιμος / naprawiany / ремонтний / reparabil / reparaturfähig / reparável / repairable



FR : Montage / ES: Montaje / PT: Montagem / IT: Montaggio / EL: Συναρμολόγηση /
 PL: Montaż / UA: Збірка / RO: Montaj / BR: Montagem / DE: Montage / EN: Assembly



FR: Utilisation / ES: Utilización / PT: Utilização / IT: Uso / EL: Χρήση / PL: Użytkowanie
 / UA: Використання / RO: Utilizare / BR: Utilização / DE: Verwenden Sie / EN: Use

**FR: CARACTÉRISTIQUES TECHNIQUES / ES: CARACTERÍSTICAS TÉCNICAS / PT: CARACTERÍSTICAS TÉCNICAS /
 IT: CARATTERISTICHE TECNICHE / EL: ΤΕΧΝΙΚΑ ΧΑΡΑΚΤΗΡΙΣΤΙΚΑ / PL: DANE TECHNICZNE / UA: ТЕХНІЧНІ
 ХАРАКТЕРИСТИКИ / RO: CARACTERISTICI TEHNICE / BR: CARACTERÍSTICAS TÉCNICAS / DE: TECHNISCHE
 CHARAKTERISTIKA / EN: TECHNICAL CHARACTERISTICS**



A1



A2



A6



A7



A9



A10



A11



A12



A13



A14



A16

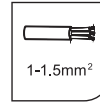

A19



A20



A21



A25

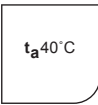

A26

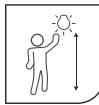

A29



E1



T6

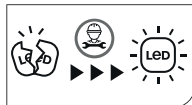

T10

- FR** Ce produit contient une source lumineuse de classe d'efficacité énergétique A
- ES** Este producto contiene una bombilla de clase de eficiencia A.
- PT** Este produto contém uma fonte de luz de eficiência energética de classe A
- IT** Questo prodotto contiene una sorgente luminosa di classe di efficienza energetica A.
- EL** Αυτό το προϊόν περιέχει πηγή φωτός κατηγορίας ενεργειακής απόδοσης A.
- PL** Niniejszy produkt zawiera źródło światła klasy efektywności energetycznej A.
- UA** Данне изделие содержит источник света класса энергоэффективности A.
- RO** Acest produs conține o sursă de lumină din clasa de eficiență energetică A.
- DE** Dieses Produkt enthält ein Licht der Energieeffizienzklasse A.
- EN** This product includes a light of the energy efficiency class A.

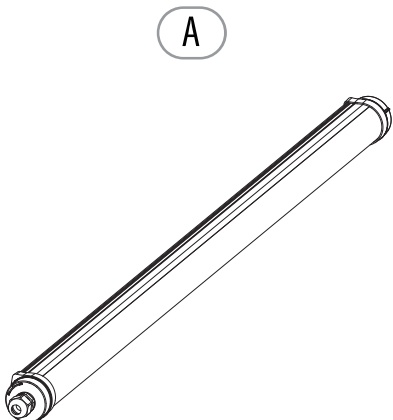

0 1 2 3 4 cm

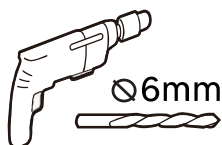
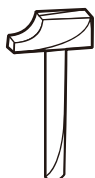
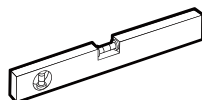
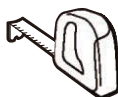
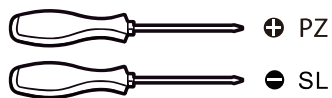
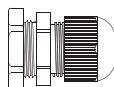
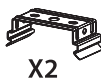
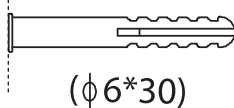
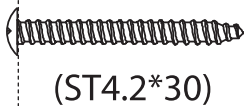

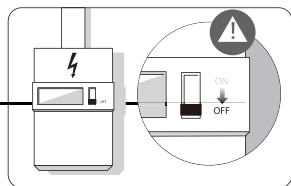
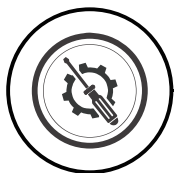

1

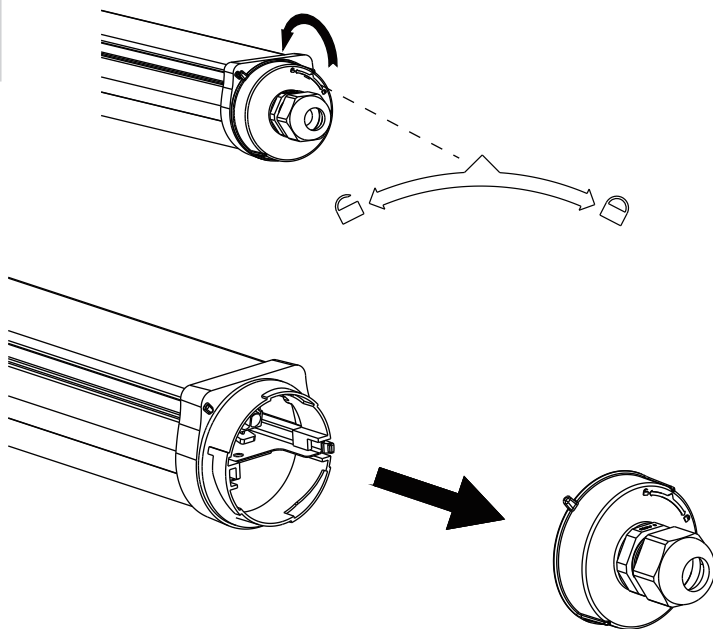

2

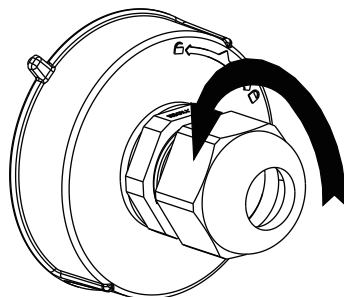

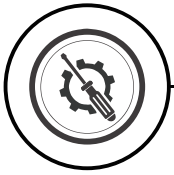

3

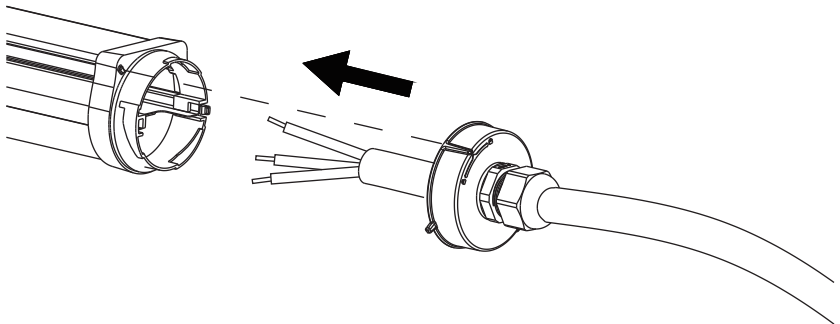
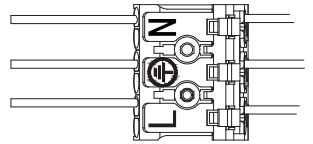
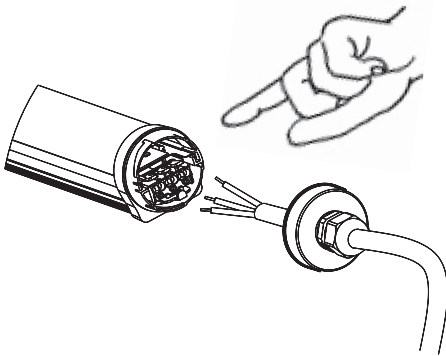
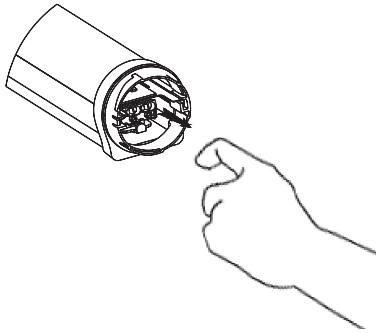
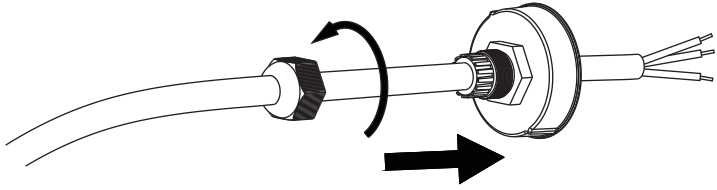

5

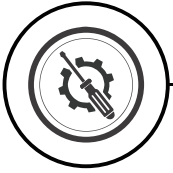

4

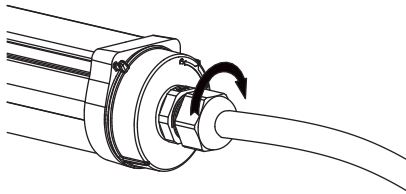
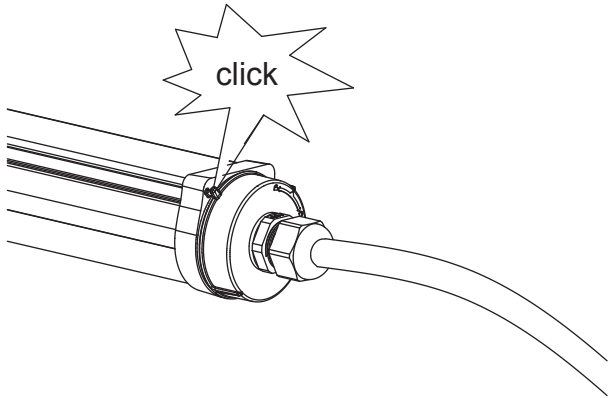
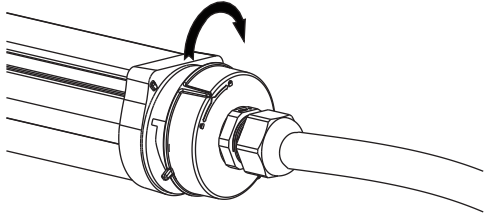



5

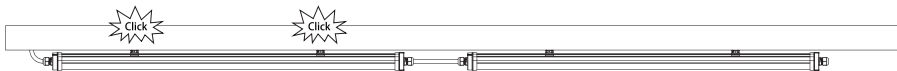

EAN	REF	luminaire can be linked	number of loop links
3276007662375	HT-CLASS A	14m	8

- FR** Spécifications de câblage : Utiliser uniquement : H05RN-F2x1,0 mm² ou H07RN-F2x1,5mm² (Attention : ne pas utiliser de fil PVC).
- ES** Especificaciones de cableado: Utilice únicamente: H05RN-F2x1,0 mm² o H07RN-F2x1,5 mm² (Advertencia: no utilice cable de PVC).
- PT** Especificação de fiação: Use apenas: H05RN-F2x1,0 mm² ou H07RN-F2x1,5mm² (Atenção: não use fio de PVC).
- IT** Specifiche di cablaggio: utilizzare solo: H05RN-F2x1,0 mm² o H07RN-F2x1,5 mm² (Attenzione: non utilizzare filo in PVC).
- EL** Προδιαγραφές καλωδίωσης: Χρησιμοποιήστε μόνο: H05RN-F2x1,0 mm² ή H07RN-F2x1,5 mm² (Προειδοποίηση: μην χρησιμοποιείτε σύρμα PVC).
- PL** Specyfikacja okablowania: Używaj wyłącznie: H05RN-F2x1,0 mm² lub H07RN-F2x1,5mm² (Ostrzeżenie: nie używaj drutu PVC).
- UA** Специфікація проводки: використовуйте лише: H05RN-F2x1,0 mm² або H07RN-F2x1,5 mm² (Попередження: не використовуйте дрiт з ПВХ).
- RO** Tehnicile caracteristice ale cablajului: folosiți numai: H05RN-F2x1,0 mm² sau H07RN-F2x1,5 mm² (Pațajurajdjanne: ne vykarystoyvayce drot z ПВХ).
- BR** Especificação de fiação: Somente use: H05RN-F2x1,0 mm² ou H07RN-F2x1,5mm² (Aviso: não use fio de PVC).
- DE** Verdrahtungsspezifikation: Nur verwenden: H05RN-F2x1,0 mm² oder H07RN-F2x1,5mm² (Warnung: Verwenden Sie keinen PVC-Draht).
- EN** Wiring specification : Only use: H05RN-F2x1,0 mm² or H07RN-F2x1,5mm² (Warning: do not use PVC wire).

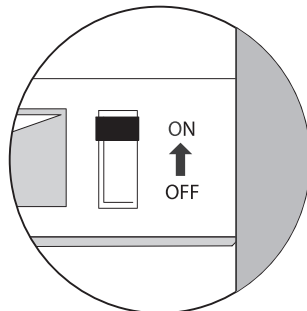



- FR** Ce produit est recyclable. S'il ne peut plus être utilisé, veuillez l'apporter dans un centre de recyclage de déchets.
- ES** Este producto es reciclable. Si ya no se puede usar, llévalo a un centro de reciclaje de residuos.
- PT** Este produto é reciclável. Se deixar de o utilizar, entregue-o num centro de reciclagem de resíduos.
- IT** Questo prodotto può essere riciclato. Se deve essere smaltito, portalo presso un centro di riciclaggio.
- EL** Αυτό το προϊόν είναι ανακυκλώσιμο. Εάν δεν μπορεί πλέον να χρησιμοποιηθεί, μεταφέρετε την σε κάποιο κέντρο ανακύκλωσης απορριμμάτων.
- PL** Ten produkt poddawany jest recyklingowi, kiedy przestaje być użyteczny należy dostarczyć go do punktu zbiórki odpadów.
- UA** Цей продукт може перероблятися. Якщо воно більше не є придатне для використання, здайте його в утилізаційний центр.
- RO** Acest produs este reciclabil. Dacă nu mai poate fi folosit, vă rugăm să îl aduceți într-un centru de reciclare a deșeurilor.
- BR** Este produto é reciclável. Se não puder mais ser usado, descarte em um centro de reciclagem de resíduos.
- DE** Dieses Produkt ist recycelbar. Wenn es nicht mehr verwendet werden kann, bringen Sie es bitte zum Recycling-Center.
- EN** This product is recyclable. If it cannot be used anymore, please take it to waste recycling centre.



FR: Traduction de la version originale du mode d'emploi / ES: Traducción de las Instrucciones originales / PT: Tradução das Instruções Originais / IT: Traduzione delle istruzioni originali / EL: Μετάφραση των πρωτότυπων οδηγιών / PL: Tłumaczenie instrukcji oryginalnej / UA: Переклад оригінальної інструкції / RO: Traducerea instrucțiunilor originale / BR: Tradução das Instruções Originais / DE: Übersetzung der Originalversion der Gebrauchsanweisung / Original Instructions.

Made in China

Країна походження: Китай

EU ADEO Services - 135 Rue Sadi Carnot - CS00001 - 59790 RONCHIN - FRANCE

UA Виробник: ТОВ "Адео Сервісес С.А.", вул. Саді Карно, CS 00001, 59790 Роншен, Франція.
Імпортер: ТОВ "Леруа Мерлен Україна", 04201 Україна, м. Київ, вул. Полярна 17А, +380 44 498 46 00. Імпортер приймає претензії від споживачів щодо товару, а також проводить його ремонт, технічне і гарантійне обслуговування

BR LEROY MERLIN COMPANHIA BRASILEIRA DE BRICOLAGEM
CNPJ: 01.438.784/0001-05
Rua Pascoal Pais, nº. 525, 6º andar cj 61 a 64, Vila Cordeiro, São Paulo - SP. CEP: 04581-060
CALM (Central de Atendimento Leroy Merlin) Capitais 4020-5376 Demais Regiões 0800-0205376

ZA Imported by Adeo South Africa (PTY) LTD T/A Leroy Merlin, Hosted in Leroy Merlin Fourways Store 35 Roos Street, Witkoppen Ext 97, Sandton, 2191 Johannesburg, Gauteng, South Africa.
Tel: +27 10 493 8000 Email: contact@leroymerlin.co.za.