

EAN : 3276007670349
Ref : HV2131K-5M

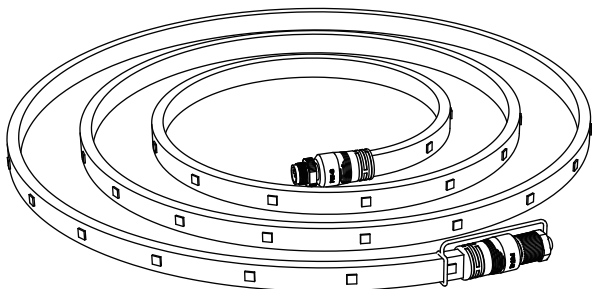

2/2



2023-07-V01

FR Manuel d'Instructions

ES Manual de Instrucciones

PT Manual de Instruções

IT Manuale di Istruzioni

EL Εγχειρίδιο Οδηγιών

PL Instrukcja Obsługi

UA Інструкція з Експлуатації

RO Manual de Instrucțiuni

BR Manual de Instrução

DE Anleitung Handbuch

EN Instructions Manual



FR : Montage / ES: Montaje / PT: Montagem / IT: Montaggio / EL: Συναρμολόγηση /
PL: Montaż / UA: Збірка / RO: Montaj / BR: Montagem / DE: Montage / EN: Assembly



FR: Utilisation / ES: Utilización / PT: Utilização / IT: Uso / EL: Χρήση / PL: Użytkowanie
/ UA: Використання / RO: Utilizare / BR: Utilização / DE: Verwenden Sie / EN: Use

FR: CARACTÉRISTIQUES TECHNIQUES / ES: CARACTERÍSTICAS TÉCNICAS / PT: CARACTERÍSTICAS TÉCNICAS /
IT: CARATTERISTICHE TECNICHE / EL: ΤΕΧΝΙΚΑ ΧΑΡΑΚΤΗΡΙΣΤΙΚΑ / PL: DANE TECHNICZNE / UA: ΤΕΧΝΙΚΗ
ΧΑΡΑΚΤΗΡΙΣΤΙΚΑ / RO: CARACTERISTICI TEHNICE / BR: CARACTERÍSTICAS TÉCNICAS / DE: TECHNISCHE
CHARAKTERISTIKA / EN: TECHNICAL CHARACTERISTICS

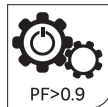
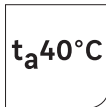

- FR** Ce produit contient une source lumineuse de classe d'efficacité énergétique E.
- ES** Este producto contiene una bombilla de clase de eficiencia E.
- PT** Este produto contém uma fonte de luz de eficiência energética de classe E.
- IT** Questo prodotto contiene una sorgente luminosa di classe di efficienza energetica E.
- EL** Αυτό το προϊόν περιέχει πηγή φωτός κατηγορίας ενεργειακής απόδοσης E.
- PL** Niniejszy produkt zawiera źródło światła klasy efektywności energetycznej E.
- UA** Данне изделие содержит источник света класса энергоэффективности E.
- RO** Acest produs conține o sursă de lumină din clasa de eficiență energetică E.
- DE** Dieses Produkt enthält ein Licht der Energieeffizienzklasse E.
- EN** This product includes a light source of the energy efficiency class E.

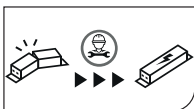
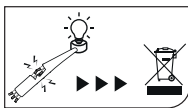
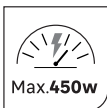
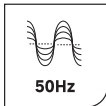
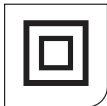
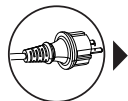
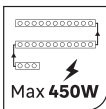
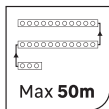
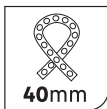
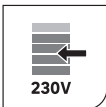
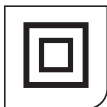

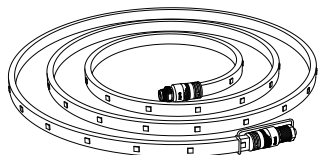

(A) x1

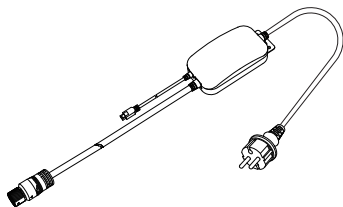

(B) x1



(C) x1

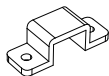

(D) x15



(E) x30



(F) x1



⊕ PZ

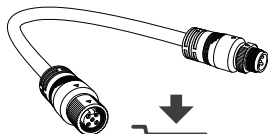

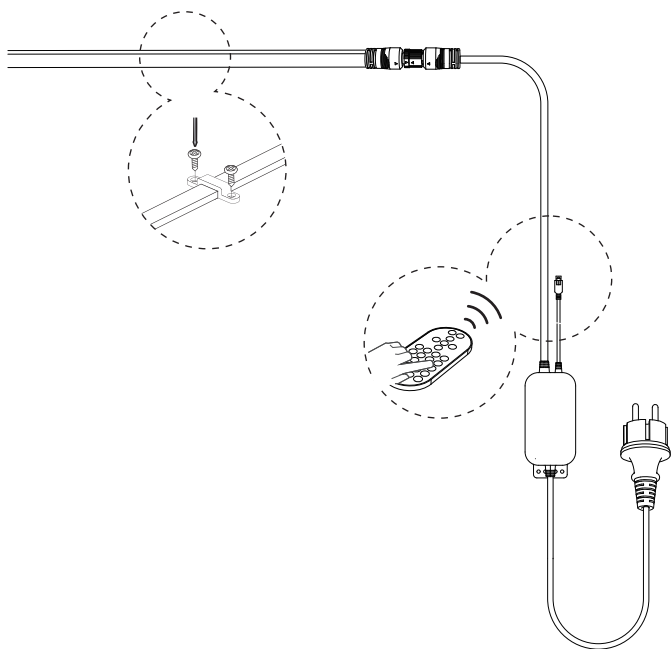



1

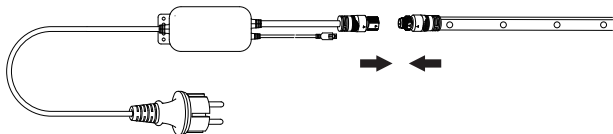

2

Max.50M

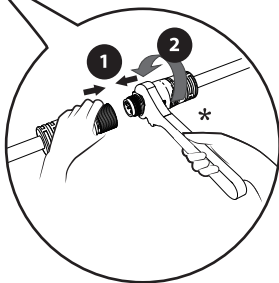

*FR: Besoin d'utiliser des outils pour verrouiller la borne et le capuchon de finition.

*ES: Necesita utilizar herramientas para bloquear la terminal y la tapa final.

*PT: Necessidade de usar ferramentas para travar o terminal e a tampa final.

*IT: Necessità di utilizzare gli strumenti per bloccare il terminale e il tappo finale.

*EL: Χρειάζεται να χρησιμοποιήσετε εργαλεία για να κλειδώσετε τον ακροδέκτη και το τέλος του καπακιού.

*PL: Konieczność użycia narzędzi do zablokowania zacisku i końcówki.

*UA: Потрібно використовувати інструменти для блокування термінала та кінцевого ковпачка.

*RO: Trebuie să utilizați unelte pentru a bloca terminalul și capătul terminalului.

*BR: Precisa usar ferramentas para travar o terminal e a tampa de extremidade.

*NL: Moet gereedschappen gebruiken om de terminal en eindkap te vergrendelen.

*DE: Werkzeuge verwenden, um das Terminal und die Endkappe zu verriegeln.

*EN: Must use tools to lock and unlock the terminal and end cap.

3

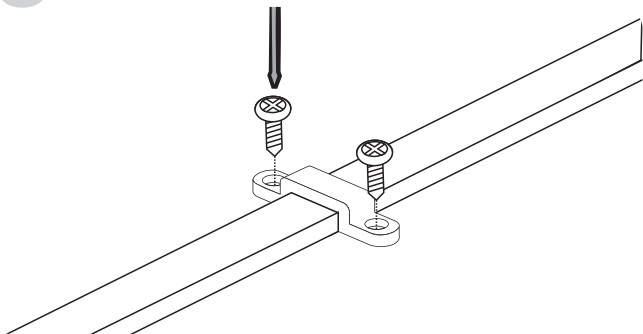

4

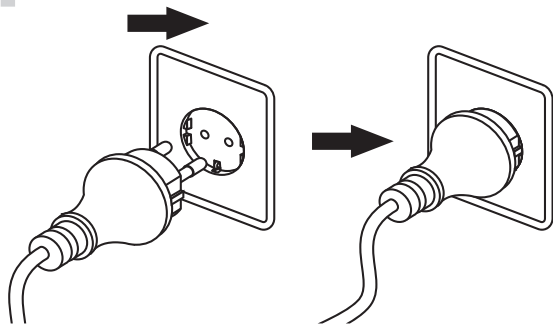

5

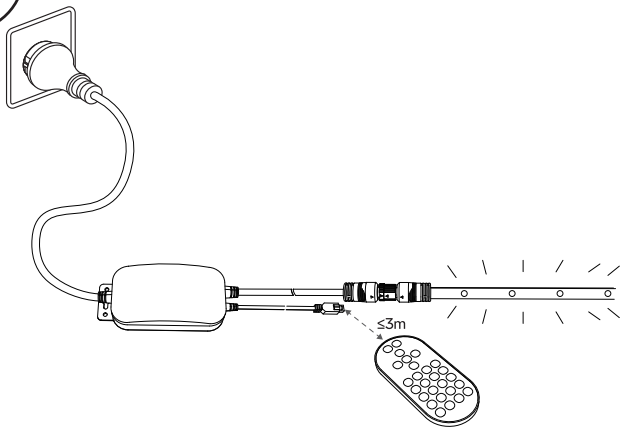
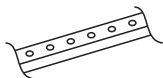
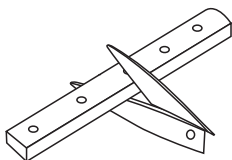
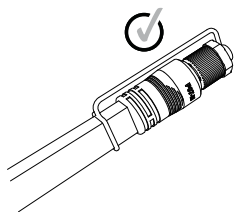
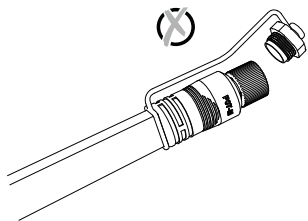



Changement de couleur/Cambio de colores/
Mudança de cores/Cambio dei colori/
Αλλαγή χρωμάτων/Zmiana kolorów/
Зміна кольорів/Schimbarea colorilor/
Mudança de cores/Farben ändern sich/
Kleuren veranderen/Colors change

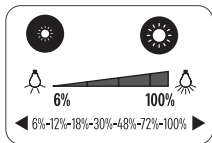
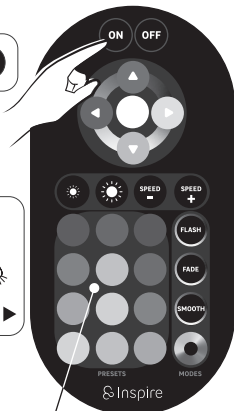

Sélecteur de couleurs /Selector de colores/
Seletor de cores/Selettore di colori/
Επιλογέας χρωμάτων/Selektor kolorów/
Селектор кольорів/Selector de culori/
Seletor de cores/Farbauswahl/
Kleurkiezer/ Color selector



Vitesse/Velocidad/Velocidade/
Velocità/Ταχύτητα/Prędkość/
Швидкість/Vitezā/Velocidade/
Geschwindigkeit/Snelheid/Speed



clignotant/destello/piscar/
lampeggiante/λάμψη/Migaç/
снaлax/intermitent/relâmpago
/flits/Blinken/Flash



Fondu/Descolorarse/Desvanecer/
sfumato/ξεθωριάζει/rozmycie/
зникати/estompare/afnemen/
desvanecimento/Verblissen/ Fade



lumière tamisée/luz tamizade/
luz difusa/Luce tenue/Λείος/
gładki/гладкий/amurg/Luz de
fundo/Glatt/gedempt licht/Smooth



Couleurs aléatoires/
Colores aleatorios/
Cores aleatórias/Colori casuali/
Τυχαία χρώματα/Losowe kolory/
Випадкові кольорі/
Culori aleatoare/Cores aleatórias/
Zufällige Farben/ Willekeurige/
Random colors

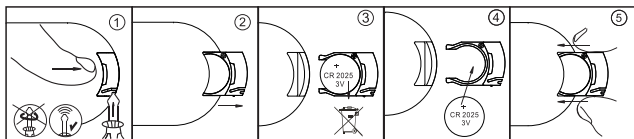



- FR** Ce produit est recyclable. S'il ne peut plus être utilisé, veuillez l'apporter dans un centre de recyclage de déchets.
- ES** Este producto es reciclable. Si ya no se puede usar, llévelo a un centro de reciclaje de residuos.
- PT** Este produto é reciclável. Se deixar de o utilizar, entregue-o num centro de reciclagem de resíduos.
- IT** Questo prodotto può essere riciclato. Se deve essere smaltito, portalo presso un centro di riciclaggio.
- EL** Αυτό το προϊόν είναι ανακυκλώσιμο. Εάν δεν μπορεί πλέον να χρησιμοποιηθεί, μεταφέρετε την σε κάποιο κέντρο ανακύκλωσης απορριμμάτων.
- PL** Ten produkt poddawany jest recyklingowi, kiedy przestaje być użyteczny należy dostarczyć go do punktu zbiórki odpadów.
- UA** Цей продукт може перероблятися. Якщо воно більше не є придатне для використання, здайте його в утилізаційний центр.
- RO** Acest produs este reciclabil. Dacă nu mai poate fi folosit, vă rugăm să îl aduceți într-un centru de reciclare a deșeurilor.
- BR** Este produto é reciclável. Se não puder mais ser usado, descarte em um centro de reciclagem de resíduos.
- DE** Dieses Produkt ist recycelbar. Wenn es nicht mehr verwendet werden kann, bringen Sie es bitte zum Recycling-Center.
- EN** This product is recyclable. If it cannot be used anymore, please take it to waste recycling centre.



FR: Traduction de la version originale du mode d'emploi / ES: Traducción de las Instrucciones originales / PT: Tradução das Instruções Originais / IT: Traduzione delle istruzioni originali / EL: Μετάφραση των πρωτότυπων οδηγιών / PL: Tłumaczenie instrukcji oryginalnej / UA: Переклад оригінальної інструкції / RO: Traducerea instrucțiunilor originale / BR: Tradução das Instruções Originais / DE: Übersetzung der Originalversion der Gebrauchsanweisung / Original Instructions.

Made in China

Країна походження: Китай

EU ADEO Services - 135 Rue Sadi Carnot - CS00001 - 59790 RONCHIN - FRANCE

UA Виробник: ТОВ "Адео Сервісес С.А.", вул. Саді Карно, CS 00001, 59790 Роншен, Франція.
Імпортер: ТОВ "Леруа Мерлен Україна", 04201 Україна, м. Київ, вул. Полярна 17А, +380 44 498 46 00. Імпортер приймає претензії від споживачів щодо товару, а також проводить його ремонт, технічне і гарантійне обслуговування

BR LEROY MERLIN COMPANHIA BRASILEIRA DE BRICOLAGEM
CNPJ: 01.438.784/0001-05
Rua Pascoal Pais, nº. 525, 6º andar cj 61 a 64, Vila Cordeiro, São Paulo - SP. CEP: 04581-060
CALM (Central de Atendimento Leroy Merlin) Capitais 4020-5376 Demais Regiões 0800-0205376

ZA Imported by Adeo South Africa (PTY) LTD T/A Leroy Merlin, Hosted in Leroy Merlin Fourways Store 35 Roos Street, Witkoppen Ext 97, Sandton, 2191 Johannesburg, Gauteng, South Africa.
Tel: +27 10 493 8000 Email: contact@leroymerlin.co.za.