



RY18LT23A



IMPORTANT!

It is essential that you read the instructions in this manual before assembling, operating, and maintaining the product.

Subject to technical modification.

Safety, performance, and dependability have been given top priority in the design of your cordless line trimmer.

INTENDED USE

The cordless line trimmer is intended to be used only by adults who have read and understood the instructions and warnings in this manual and can be considered responsible for their actions.

The product is intended only for outdoor use in a well-ventilated area. For safety reasons, the product must be adequately controlled by a two-handed operation.

When fitted with the line trimmer head (and appropriate guard), the product is intended for cutting long grass, pulpy weed, and similar vegetation at or about ground level. The cutting plane should be approximately parallel to the ground surface.

The cutting plane should be approximately parallel to the ground surface when trimming and approximately vertical when edging.

The product should not be used to cut or trim hedges, bushes, or other vegetation where the cutting plane is not parallel to the ground surface.

Do not use the product for any other purpose.

GENERAL SAFETY WARNINGS

⚠ WARNING! Read all safety warnings and all instructions. Failure to follow the warnings and instructions may result in electric shock, fire, and/or serious injury.

- When using the product, the safety rules must be followed. For your own safety and that of bystanders, please read these instructions before operating the product. Please keep the instructions safe for later use.
- The product is not intended to be used by children or persons with reduced physical, mental, or sensory capabilities. Children should be adequately supervised to ensure that they do not play with the product.
- Some regions have regulations that restrict the use of the product. Check with your local authority for advice.

TRAINING

- Read the instructions carefully. Be familiar with all controls and the proper use of the product.
- Never allow children or people who are unfamiliar with these instructions to use the product. Local regulations may restrict the age of the operator.
- Keep bystanders, children, and pets 15 m away from the area of operation. Turn off the product if anyone enters the area.
- Never use the product while tired, ill, or under the influence of alcohol, drugs, or medication.
- Keep in mind that the operator or user is responsible for accidents or hazards occurring to other people or their property.

PREPARATION

- Wear full eye and hearing protection while operating the product. If working in an area where there is a risk of falling objects, head protection must be worn.
- Hearing protection may restrict the operator's ability to hear warning sounds. Pay particular attention to potential hazards around and inside the working area.
- Wear heavy, long trousers, boots, and gloves. Do not wear loose-fitting clothing, short trousers, or jewellery of any kind. Do not use the product with bare feet.
- Secure long hair so that it is above shoulder level to prevent entanglement in moving parts.
- Before use and after any impact, check that there are no damaged parts on the product. A defective switch or any part that is damaged or worn should be properly repaired or replaced by an authorised service centre.
- Make sure that the cutting attachment is properly installed and securely fastened.
- Never operate the product unless all guards, deflectors, and handles are properly and securely attached.
- Consider the environment in which you are working. Keep the working area free from wires, sticks, stones, and debris, which if struck by the cutter, can become thrown objects.

BATTERY TOOL USE AND CARE

- Recharge only with the charger specified by the manufacturer. A charger that is suitable for one type of battery pack may create a risk of fire when used with another battery pack.
- Use power tools only with specifically designated battery packs. Use of any other battery packs may create a risk of injury and fire.
- When the battery pack is not in use, keep it away from other metal objects, like paper clips, coins, keys, nails, screws or other small metal objects that can make a connection from one terminal to another. Shorting the battery terminals together may cause burns or a fire.
- Under abusive conditions, liquid may be ejected from the battery; avoid contact. If contact accidentally occurs, flush with water. If liquid contacts eyes, additionally seek medical help. Liquid ejected from the battery may cause irritation or burns.

LINE TRIMMER SAFETY WARNINGS

- Never allow children, persons with reduced physical, sensory, or mental capabilities or lack of experience and knowledge, or people who are unfamiliar with the instructions to use the product.
- Use the product in daylight or with good artificial light.
- Avoid using the product on wet grass.
- Keep firm footing and balance at all times, and be sure of proper footing on slopes.
- Do not walk backwards when using the product. Walk, never run.
- Keep the head attachment below waist level.
- Never use the product with damaged guards or without guards in place.
- Never fit a metal replacement line.
- Keep hands and feet away from the cutting means at all times, especially when turning on the motor.

- Beware, the cutting elements continue to rotate after the motor is turned off.
- Beware of objects thrown by the cutting means. Clear debris like small stones, gravel, and other foreign objects from the work area before starting the operation. Wires or string may become entangled with the cutting means.
- To reduce the risk of injury associated with contacting moving parts, always turn off the product, remove the battery pack, and allow both to cool down. Make sure that all moving parts have come to a complete stop:
 - before servicing
 - before clearing a blockage
 - before checking, cleaning, and working on the product
 - before changing accessories
 - after striking a foreign object
 - whenever leaving the product unattended
 - whenever performing maintenance
 - whenever the product starts to vibrate abnormally
- Wear full eye and hearing protection while operating the product. If working in an area where there is a risk of falling objects, head protection must be worn.
- Hearing protection may restrict the operator's ability to hear warning sounds. Pay particular attention to potential hazards around and inside the working area.
- Wear heavy, long trousers, boots, and gloves. Do not wear loose-fitting clothing, short trousers, or jewellery of any kind. Do not use the product with bare feet.
- Secure long hair so that it is above shoulder level to prevent entanglement in moving parts.
- The small blade fitted to the lawn guard is designed to trim the newly extended line to the correct length for safe and optimum performance. The blade is very sharp. Do not touch the blade, particularly when cleaning the product.
- Always ensure that ventilation openings are kept clear of debris.
- Before use and after any impact, check that there are no damaged parts on the product. A defective switch or any part that is damaged or worn should be properly repaired or replaced by an authorised service centre.
- Make sure that the cutting head attachment is properly installed and securely fastened.
- Make sure that all guards, deflectors, and handles are properly and securely attached.
- Do not modify the product in any way. This may increase the risk of injury to yourself or others.
- Use only the manufacturer's replacement cutting line. Do not use any other cutting attachment.
- Immediately turn off the product and remove the battery pack in the event of an accident or breakdown. Do not operate the product again until it has been fully checked by an authorised service centre.
- Ensure that the line cut-off blade in the guard is properly positioned and secured before each use.

ADDITIONAL BATTERY SAFETY WARNINGS

To reduce the risk of fire, personal injury, and product damage due to a short circuit, never immerse the tool, battery pack, or charger in fluid or allow fluid to flow inside them. Corrosive or conductive fluids, such as seawater, certain industrial chemicals, and bleach or bleach-containing products, etc., can cause a short circuit.

TRANSPORTATION AND STORAGE

- Turn off the product, remove the battery pack, and allow both to cool down before storing or transporting.
- Remove all foreign materials from the product.
- Do not store or transport the product with the battery pack fitted. Remove the battery pack, and secure it separately. Store the product in a cool, dry, and well-ventilated place that is inaccessible to children. Keep the product away from corrosive agents, such as garden chemicals and de-icing salts. Do not store the product outdoors.
- For transportation in vehicles, secure the product against movement or falling to prevent injury to persons or damage to the product.

TRANSPORTING LITHIUM BATTERIES

- Transport the battery pack in accordance with local and national provisions and regulations.
- Follow all special requirements on packaging and labelling when transporting batteries by a third party. Ensure that no batteries can come in contact with other batteries or conductive materials while in transport by protecting exposed connectors with insulating, nonconductive caps or tape. Do not transport batteries that are cracked or leaking. Check with the forwarding company for further advice.

MAINTENANCE

- Use only original manufacturer's replacement parts, accessories, and attachments. Failure to do so can cause possible injury, can contribute to poor performance, and may void your warranty.
- Servicing requires extreme care and knowledge and should be performed only by a qualified service technician. Have the product serviced by an authorised service centre only.
- Turn off the product and remove the battery back before conducting any maintenance or cleaning work.
- You may make adjustments or repairs described in this manual. For other repairs, contact an authorised service centre.
- For the replacement line, use only a nylon filament line of the diameter described in the specifications table of this manual.
- After each use, clean the product with a soft, dry cloth. Any part that is damaged should be properly repaired or replaced by an authorised service centre.
- Check all nuts, bolts, and screws before each use and at frequent intervals for proper tightness to ensure that the product is in safe working condition. Any part that is damaged should be properly repaired or replaced by an authorised service centre.

- Bring the product to an authorised service centre to replace damaged or unreadable labels.
- Injuries may be caused, or aggravated, by prolonged use of a tool. When using any tool for prolonged periods, ensure that you take regular breaks.

KNOW YOUR PRODUCT

See page 5.

1. Rear handle
2. Lock-out trigger
3. On/Off trigger
4. Edging button
5. Front handle
6. Drive shaft
7. Spool cover
8. Spool
9. Eyelet
10. Slider
11. Flailing blade
12. Cutting line
13. Screws
14. Operator's manual
15. Safety guard
16. Cut-off blade
17. Battery pack
18. Charger

SYMBOLS ON THE PRODUCT



Read and understand all the instructions before operating the product. Follow all the warnings and safety instructions.



Beware of thrown or flying objects. Keep all bystanders, especially children and pets, at least 15 m away from the operating area.



Wear eye protection.



Wear ear protection.



Do not use metal blades on the product.



Do not expose the product to rain or damp condition.



Keep hands away from blades.



Waste electrical products should not be disposed of with household waste. Please recycle where facilities exist. Check with your local authority or retailer for recycling advice.



Guaranteed sound power level



European Conformity Mark



British Conformity Mark



EurAsian Conformity Mark



Ukraine Conformity Mark

SYMBOLS IN THIS MANUAL



Parts or accessories sold separately



Note



Warning

RY18LT23A-0

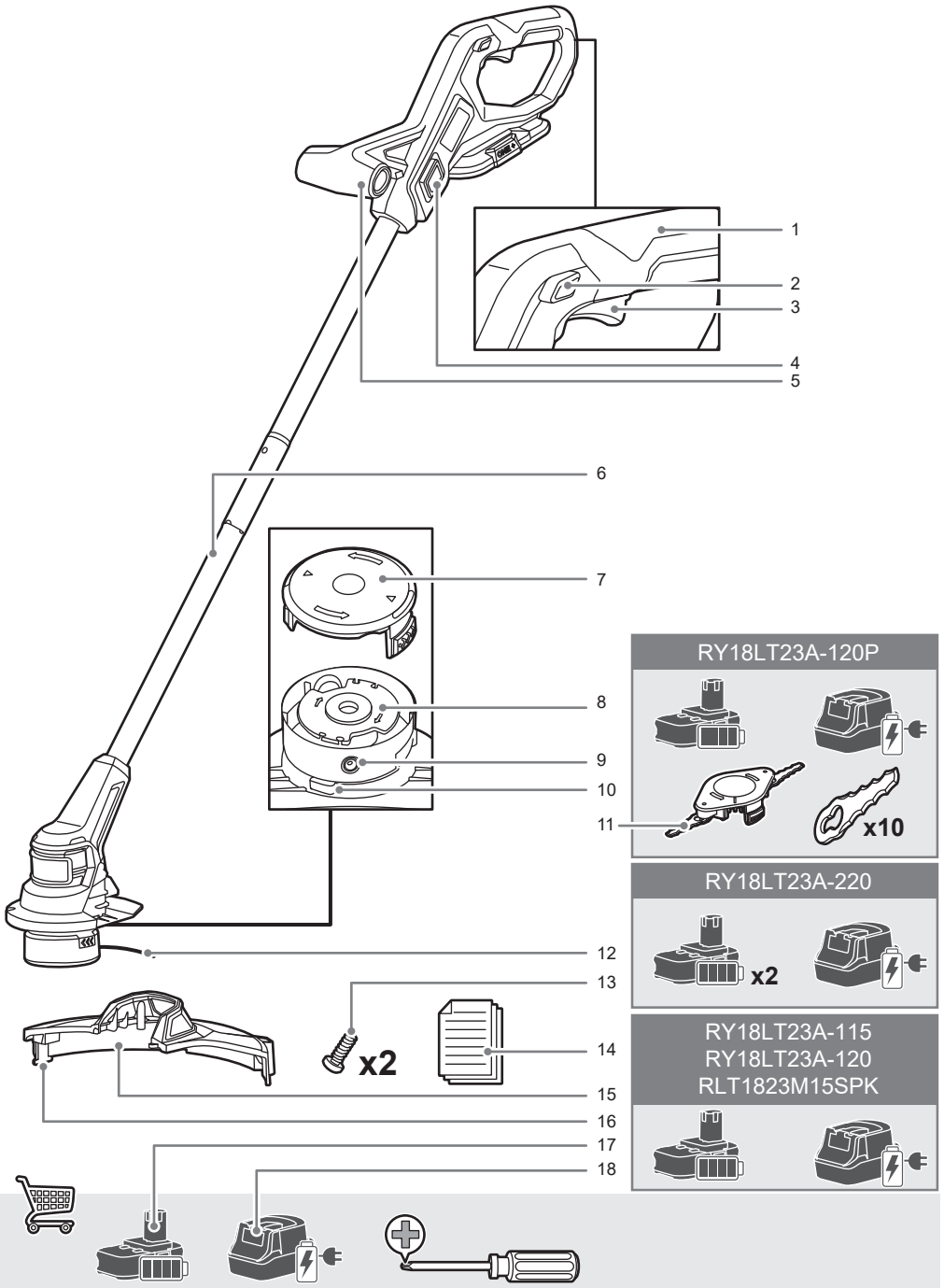

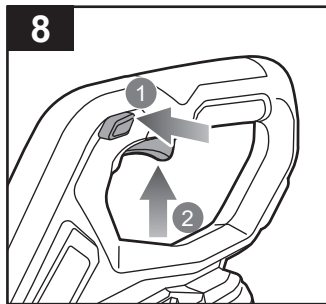
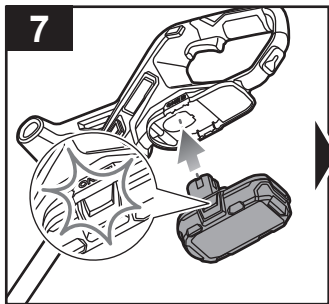
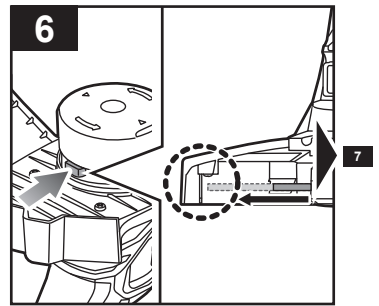
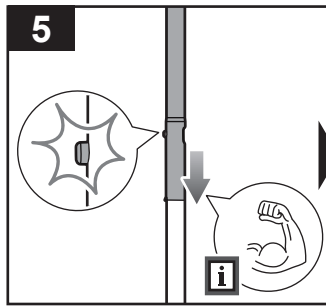
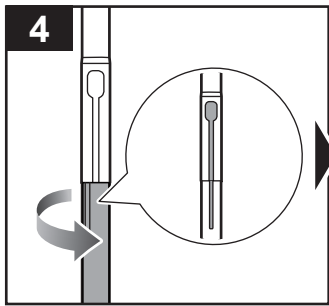
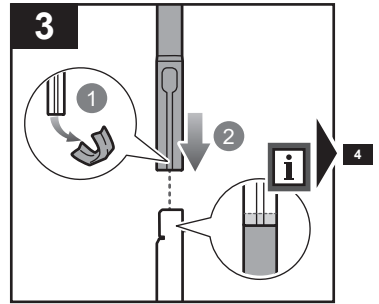
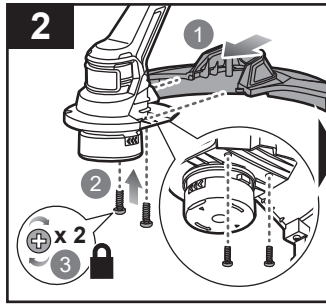
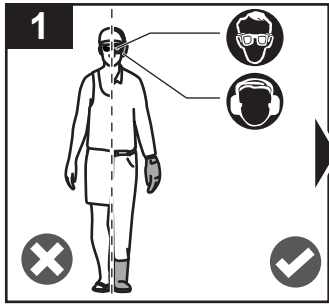

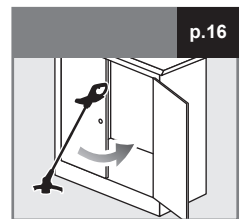
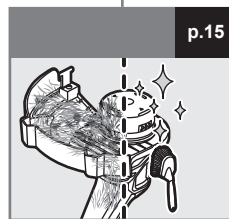
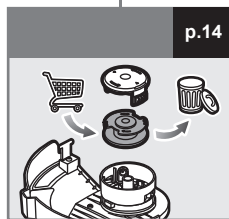
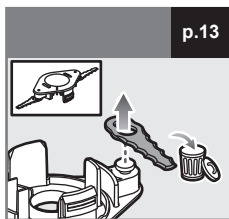
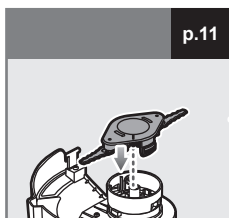
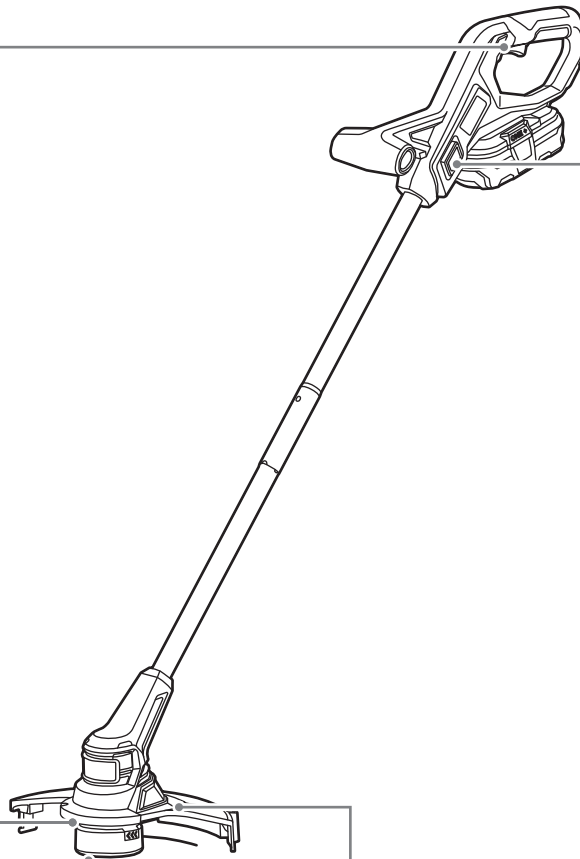
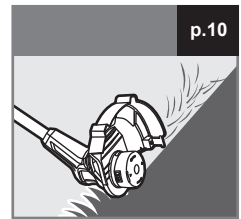
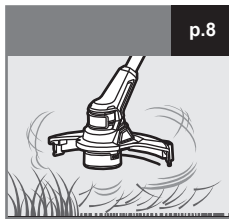

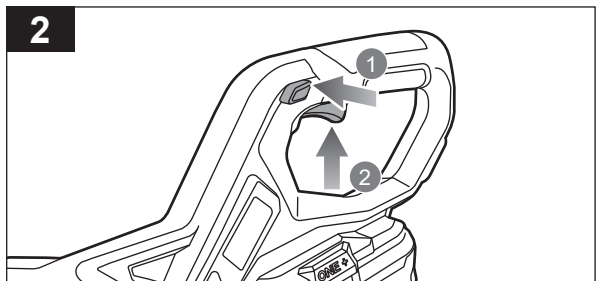
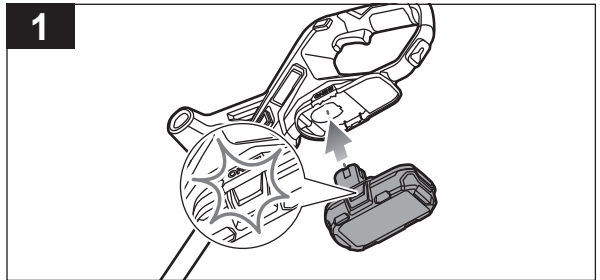
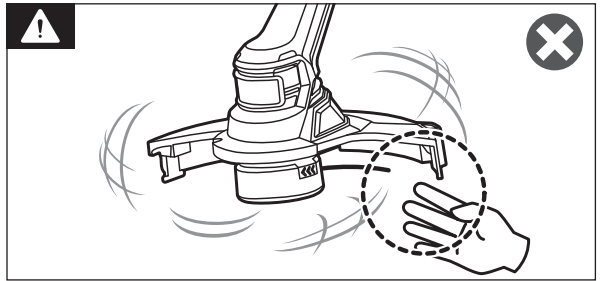
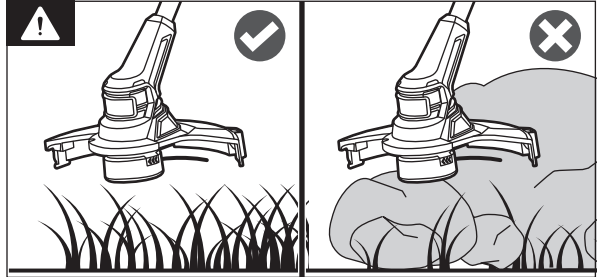
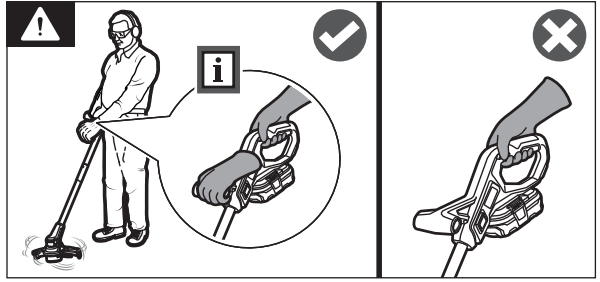
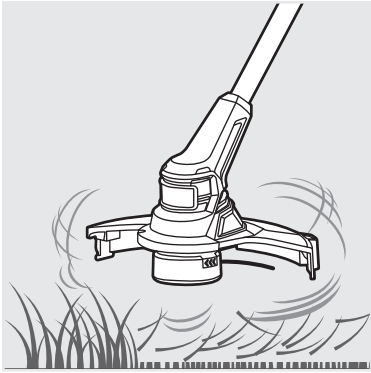

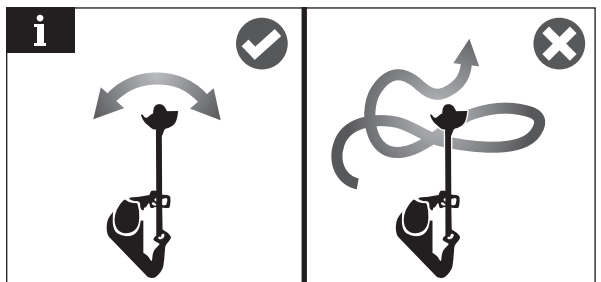
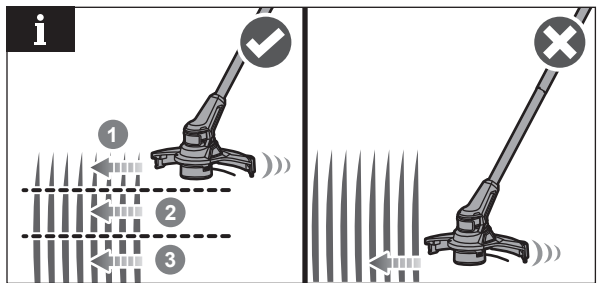
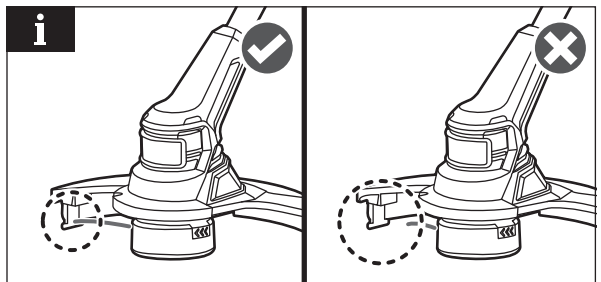
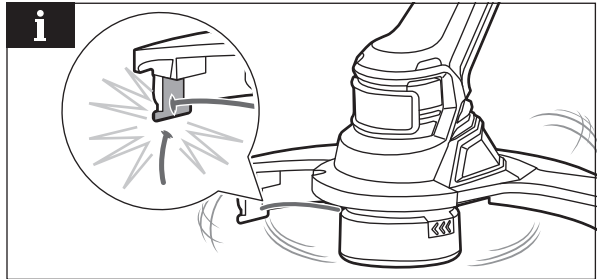
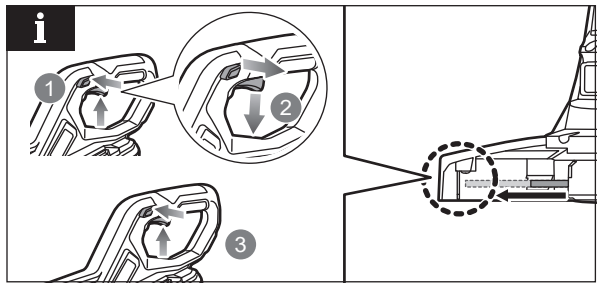

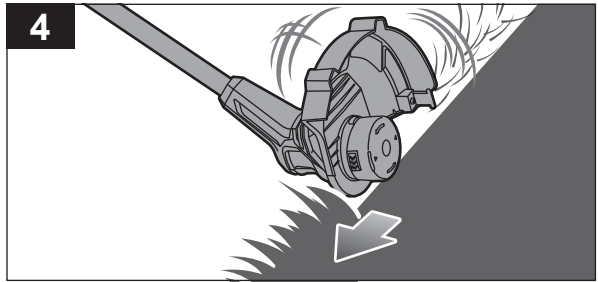
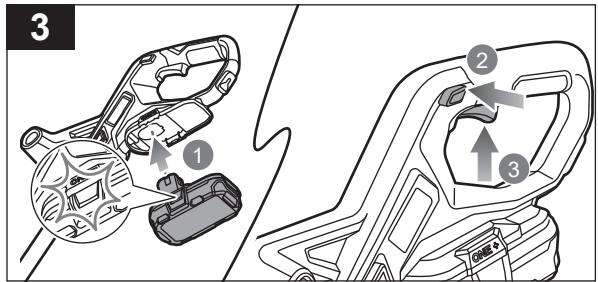
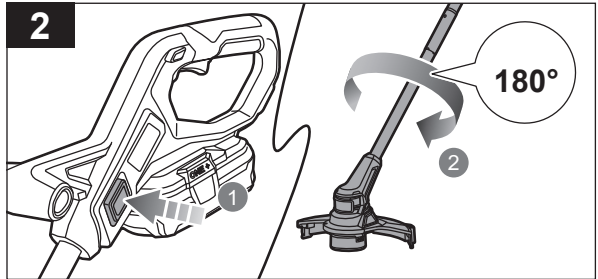
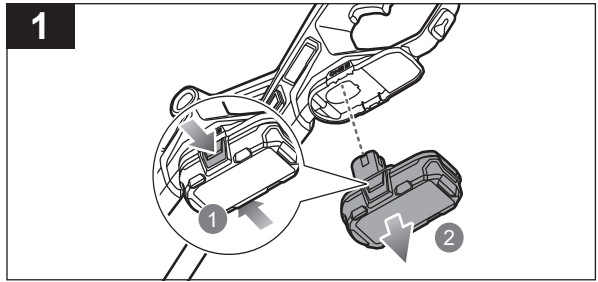
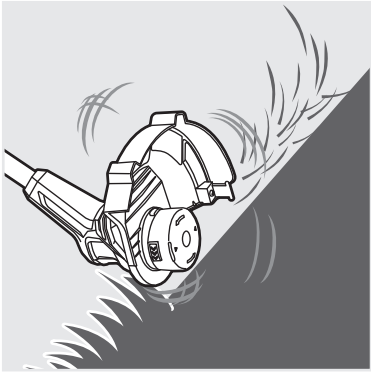

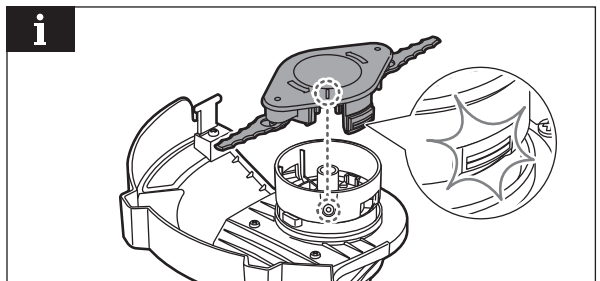
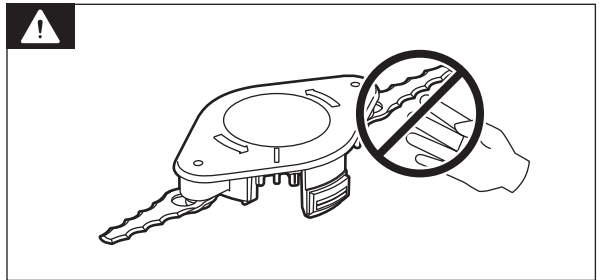
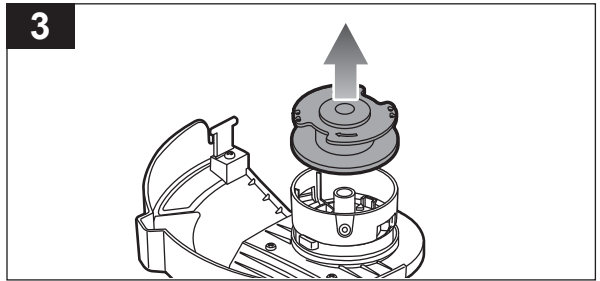
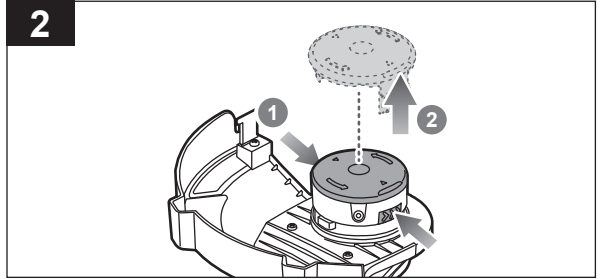
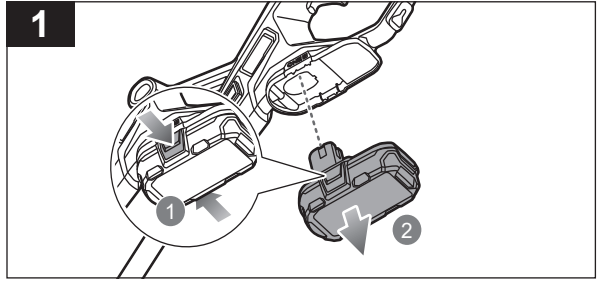
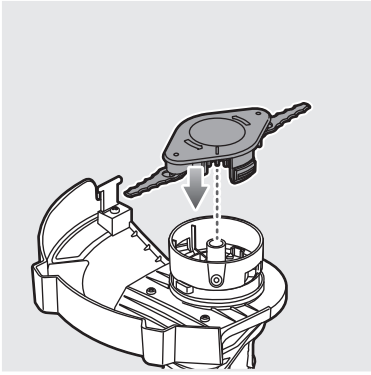

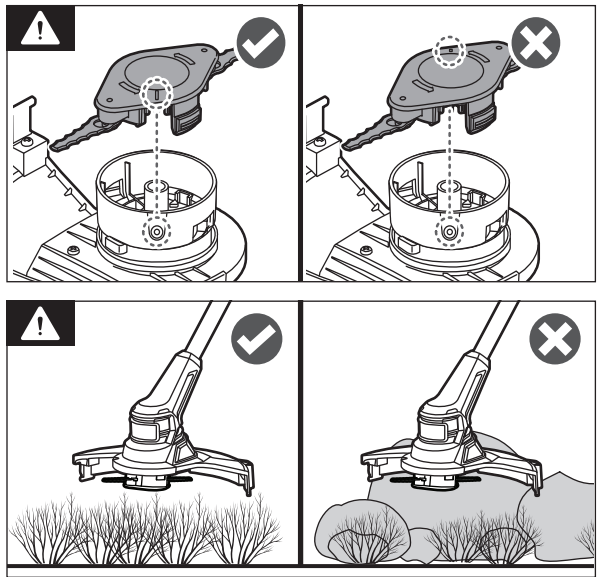

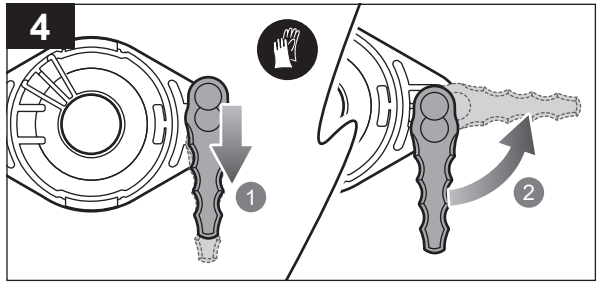
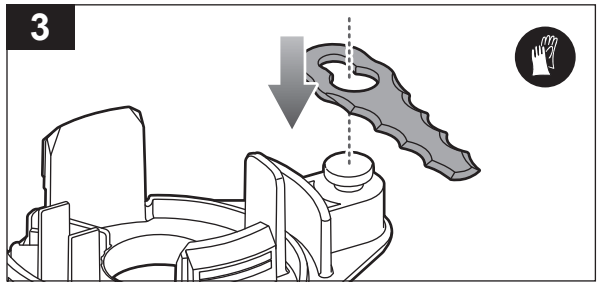
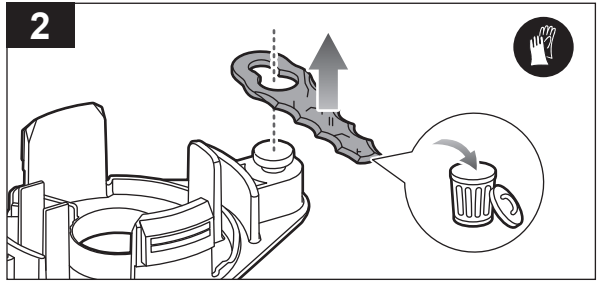
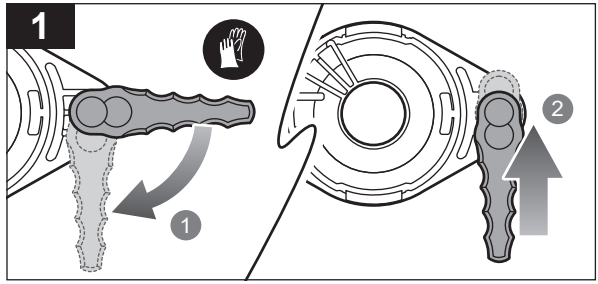
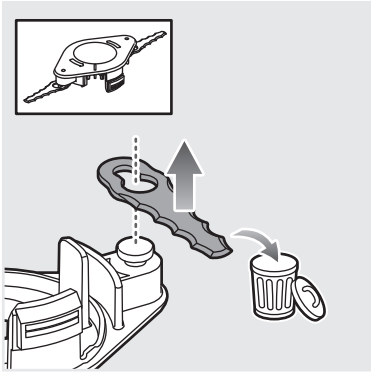

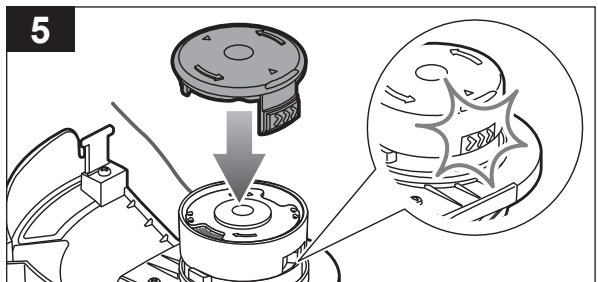
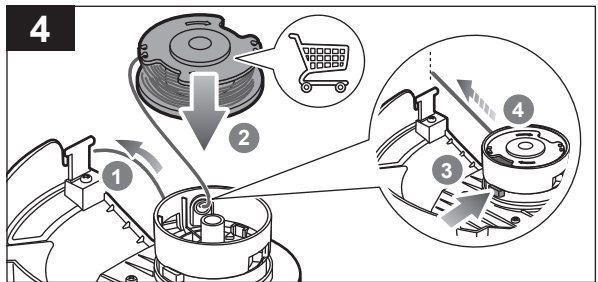
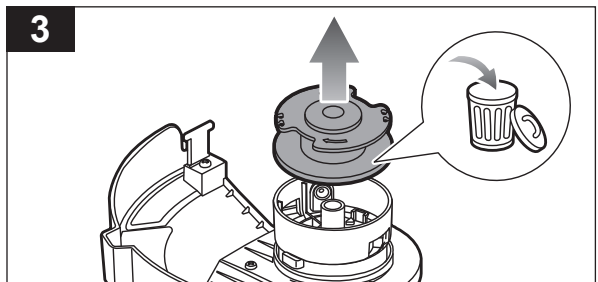
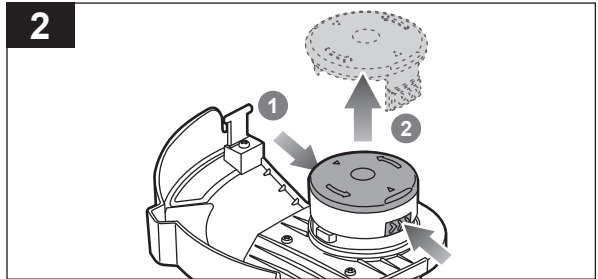
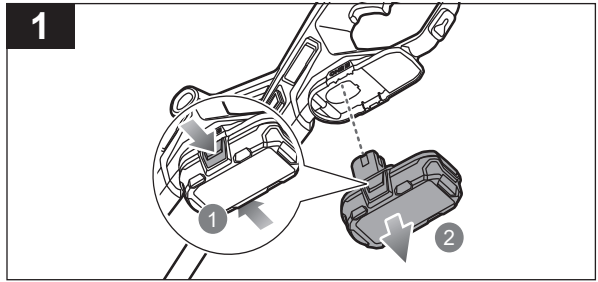
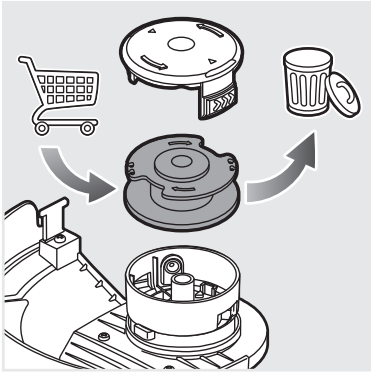

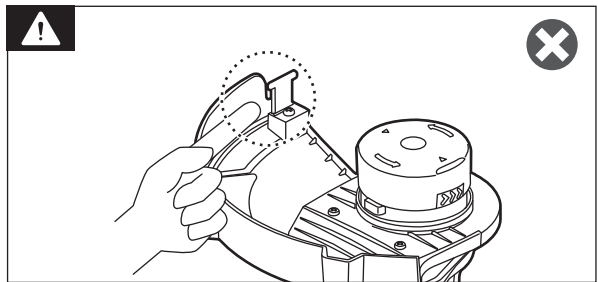
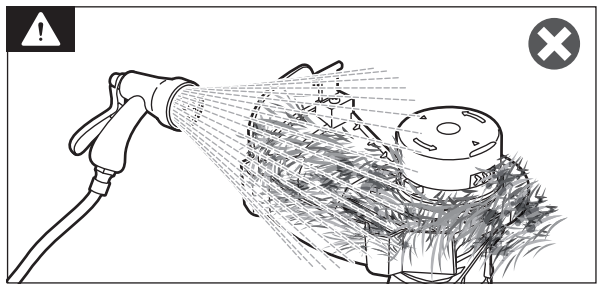
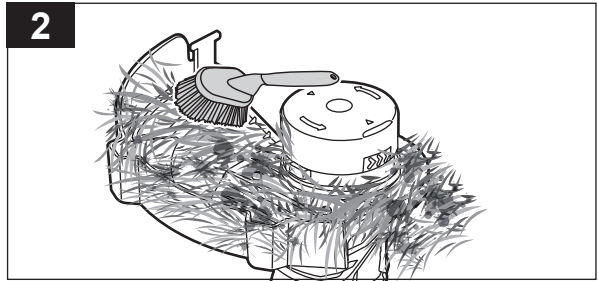
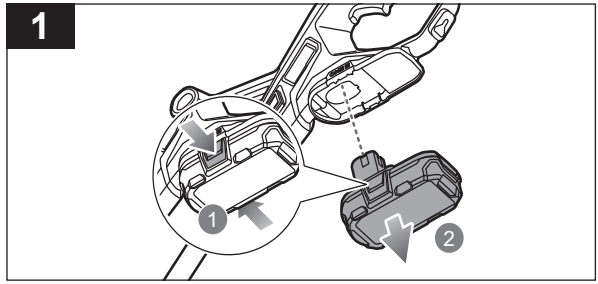
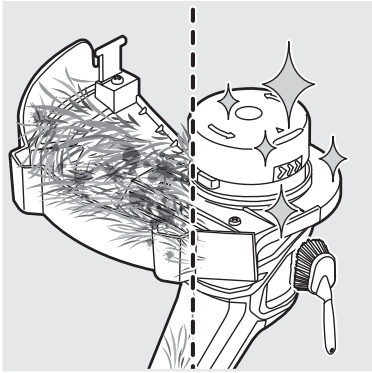

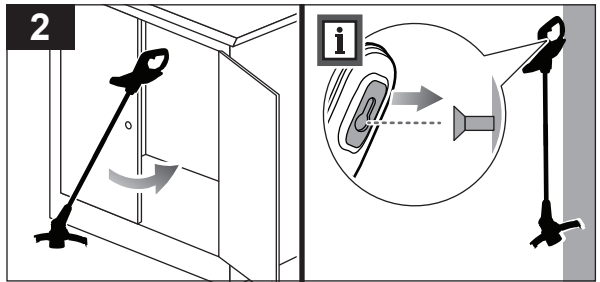
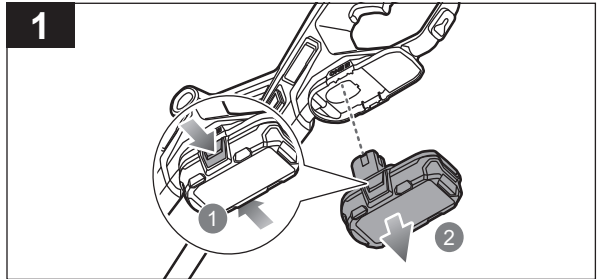
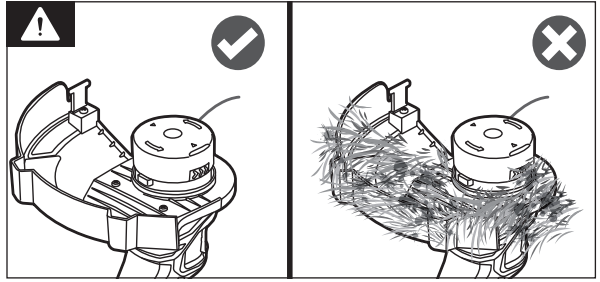
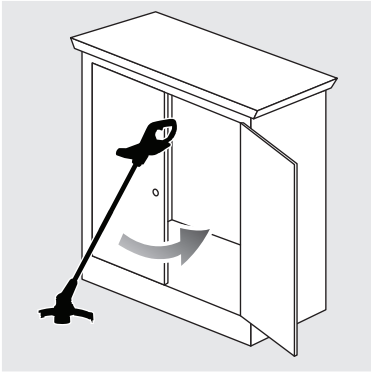

PRODUCT SPECIFICATIONS

Cordless line trimmer

Model RY18LT23A

Voltage 18 V

No-load speed 9, 500 min⁻¹

Cutting capacity 23 cm

Cutting line diameter 1.6 mm

Cutting capacity (flailing blade) 224 mm

Vibration level (in accordance with EN 50636-2-91 Annex BB)

Line trimmer

Rear handle $a_h = 2.5 \text{ m/s}^2$

Front handle $a_h = 1.6 \text{ m/s}^2$

Uncertainty $K = 1.5 \text{ m/s}^2$

Flailing blade

Rear handle $a_h = 5.2 \text{ m/s}^2$

Front handle $a_h = 3.5 \text{ m/s}^2$

Uncertainty $K = 1.5 \text{ m/s}^2$

Noise emission level (in accordance with EN 50636-2-91 Annex CC)

Line trimmer

A-weighted sound pressure level $L_{pA} = 78.6 \text{ dB(A)}$

Uncertainty $K_{pA} = 3.0 \text{ dB}$

A-weighted sound power level $L_{WA} = 90.1 \text{ dB(A)}$

Uncertainty $K_{WA} = 1.6 \text{ dB}$

$L_{WA} + K_{WA} = 92 \text{ dB(A)}$

Flailing blade

A-weighted sound pressure level $L_{pA} = 81.4 \text{ dB(A)}$

Uncertainty $K_{pA} = 3.0 \text{ dB}$

A-weighted sound power level $L_{WA} = 92.6 \text{ dB(A)}$

Uncertainty $K_{WA} = 0.8 \text{ dB}$

$L_{WA} + K_{WA} = 94 \text{ dB(A)}$

BATTERY AND CHARGER

Model RY18LT23A-115 RY18LT23A-120 RY18LT23A-120P

Battery pack 1.5 Ah 2 Ah 2 Ah

Charger RC18115

Compatible battery packs BPL-18..., RB18..

Compatible chargers BC-18..., BCL-18..., BCL1418..., RC18..

Model RY18LT23A-220 RLT1823M15SPK

Battery pack 2 Ah x 2 1.5 Ah

Charger RC18115

Compatible battery packs BPL-18..., RB18..

Compatible chargers BC-18..., BCL-18..., BCL1418..., RC18..

REPLACEMENT PARTS

1.6 mm cutting line RAC124

Complete spool (3 pcs) RAC125

Heavy-duty blades RAC155

Heavy-duty replacement blades RAC158

NOTE: Visit your local special orders desk or contact RYOBI Customer Service for replacement parts.

⚠ WARNING! The declared vibration total values and the declared noise emission values given in this instruction manual have been measured in accordance with a standardised test and may be used to compare one tool with another. They may be used for a preliminary assessment of exposure.

The declared vibration and noise emission values represent the main applications of the tool. However, if the tool is used for different applications, used with different accessories, or poorly maintained, the vibration and noise emission may differ. These conditions may significantly increase the exposure levels over the total working period. An estimation of the level of exposure to vibration and noise should take into account the times when the tool is turned off or when it is running idle. These conditions may significantly reduce the exposure level over the total working period.

Identify additional safety measures to protect the operator from the effects of vibration and noise, such as maintaining the tool and the accessories, keeping the hands warm (in case of vibration), and organising work patterns.

RYOBI WARRANTY APPLICATION CONDITIONS

In addition to any statutory rights resulting from the purchase, this product is covered by a warranty as stated below.

1. The warranty period is 24 months for consumers and commences on the date when the product was purchased. This date has to be documented by an invoice or other proof of purchase. The product is designed and dedicated to consumer and private use only. So there is no warranty provided in case of professional or commercial use. This warranty applies only on new products.
2. There is a possibility to extend for a part of the range of power tools (AC/DC) the warranty period over the period described above using the registration on the www.ryobitools.eu website. The eligibility of products for extended warranty is clearly displayed in stores and / or on packaging and is contained within the product documentation. The end user is required to register his/her newly-acquired products online within 30 days from the date of purchase. The end user may register for the extended warranty in his/her country of residence if listed on the online registration form where this option is valid. Furthermore, end users must give their consent to the storage of their personal data that is required to be entered online. They must also accept the terms and conditions. The registration confirmation receipt, which is sent out by e-mail, and the original invoice showing the date of purchase will serve as proof of the extended warranty.
3. The warranty covers all defects of the product during the warranty period due to faults in workmanship or material at the purchase date. The warranty is limited to repair and/or replacement and does not include any other obligations including but not limited to incidental or consequential damages. The warranty is not valid if the product has been misused, used contrary to the instruction manual, or has been incorrectly connected to a power supply. This warranty does not apply to:
 - any damage to the product that is the result of improper or lack of maintenance
 - any product that has been altered or modified
 - any product where original identification (trade mark, serial number) markings have been defaced, altered or removed
 - any damage caused by non-observance of the instruction manual
 - any product not displaying the CE approval mark on the rating plate
 - any product that has been attempted to be repaired by a non-authorized warranty service centre or without prior authorisation by Techntronic Industries
 - any product connected to improper power supply (amps, voltage, frequency)
 - any product used with inappropriate fuel mixture (fuel, oil, ratio of oil/ fuel mixture)
 - any damage caused by external influences (water, chemical, physical, shocks) or foreign substances
 - normal wear and tear spare parts
 - inappropriate use, overloading of the tool
 - use of non-approved accessories or parts
 - Accessories provided with the tool or purchased separately including but not limited to blades, saw chains, cutting lines, etc.
 - Any periodic adjustments to or maintenance cleaning of carburettors
 - Components (parts and accessories) subject to natural wear and tear, including but not limited to bump knobs, drive belts, clutch, blades of hedge trimmers or lawn mowers, harness, cable throttle, carbon brushes, power cord, tines, felt washers, hitch pins, blower fans, blower and vacuum tubes, vacuum bag and straps, guide bars, saw chains, hoses, connector fittings, spray nozzles, wheels, spray wands, inner reels, outer spools, cutting lines, spark plugs, air filters, gas filters, mulching blades, etc.
4. For servicing, the product must be sent or presented to a RYOBI authorised service station listed for each country in the following list of service station addresses. In some countries your local RYOBI dealer undertakes to send the product to the RYOBI service organisation. When sending a product to a RYOBI service station, the product should be safely packed without any dangerous contents such as petrol, marked with sender's address and accompanied by a short description of the fault.
5. A repair / replacement under this warranty is free of charge. It does not constitute an extension or a new start of the warranty period. Exchanged parts or products become our property. In some countries delivery charges or postage will have to be paid by the sender. Your statutory rights arising from the purchase of the product remain unaffected.
6. This warranty is valid in the European Community, Switzerland, Iceland, Norway, Liechtenstein, Turkey, Russia, and the United Kingdom. Outside these areas, please contact your authorised RYOBI dealer to determine if another warranty applies.

AUTHORISED SERVICE CENTRE

Any request or issue with the product can be addressed to your local authorised service centres (visit www.ryobitools.eu) or directly to: Techntronic Industries GmbH, Max Eyth Straße 10, 71364 Winnenden, Germany. Please state the serial number and product type printed on the label.

RYOBI is a trade mark of Ryobi Limited, and is used under license.

EC DECLARATION OF CONFORMITY

Manufacturer: Techntronic Industries GmbH
Max-Eyth-Straße 10, 71364 Winnenden, Germany

We declare as the manufacturer under our sole responsibility that the product mentioned below

Cordless line trimmer
Brand: RYOBI
Model number: RY18LT23A
Serial number range: 47592801000001 - 47592801999999

fulfills all the relevant provisions of the following European Directives, European Regulations and harmonised standards:

2006/42/EC, 2014/30/EU, 2000/14/EC, 2005/88/EC, 2011/65/EU,
EN 60335-1:2012+A11:2014+A13:2017+A1:2019+A14:2019+A2:2019,
EN 50636-2-91:2014, EN IEC 55014-1:2021, EN IEC 55014-2:2021,
EN IEC 63000:2018, EN 62233:2008

Measured sound power level: 92.6 dB(A)
Guaranteed sound power level: 95 dB(A)

Conformity assessment method to Annex VI Directive 2000/14/EC amended by 2005/88/EC.

Notified body:
No. 0197 – TÜV Rheinland LGA Products GmbH
Tillystraße 2 - 90431 Nürnberg – Germany



Todd Chipner
Vice President, Quality – Asia
Winnenden, Dec. 23, 2021

Authorised to compile the technical file:
Alexander Krug, Managing Director
Techntronic Industries GmbH
Max-Eyth-Straße 10, 71364 Winnenden, Germany

GB-DECLARATION OF CONFORMITY

Manufacturer: Techntronic Industries GmbH
Max-Eyth-Straße 10, 71364 Winnenden, Germany

We declare as the manufacturer under our sole responsibility that the product mentioned below

Cordless line trimmer
Brand: RYOBI
Model number: RY18LT23A
Serial number range: 47592801000001 - 47592801999999

fulfills all the relevant provisions of the following Regulations: S.I. 2008/1597 (as amended), S.I. 2016/1091 (as amended), S.I. 2012/3032 (as amended), S.I. 2001/1701 (as amended) and that the following designated standards have been used:

BS EN 60335-1:2012+A2:2019, BS EN 50636-2-91:2014,
BS EN IEC 55014-1:2021, BS EN IEC 55014-2:2021,
BS EN IEC 63000:2018, BS EN 62233:2008

Measured sound power level: 92.6 dB(A)
Guaranteed sound power level: 95 dB(A)

Conformity assessment method to S.I. 2001/1701 Schedule 9 (as amended)

Approved body:
No. 8500 – AnP Certification Limited
2 Parkfield Street, Rusholme, Manchester, M14 4PN, United Kingdom



Todd Chipner
Vice President, Quality – Asia
Winnenden, Dec. 23, 2021

Authorised to compile the technical file:
Techntronic Industries (UK) Ltd
Fieldhouse Lane
Marlow Bucks SL7 1HZ
UK



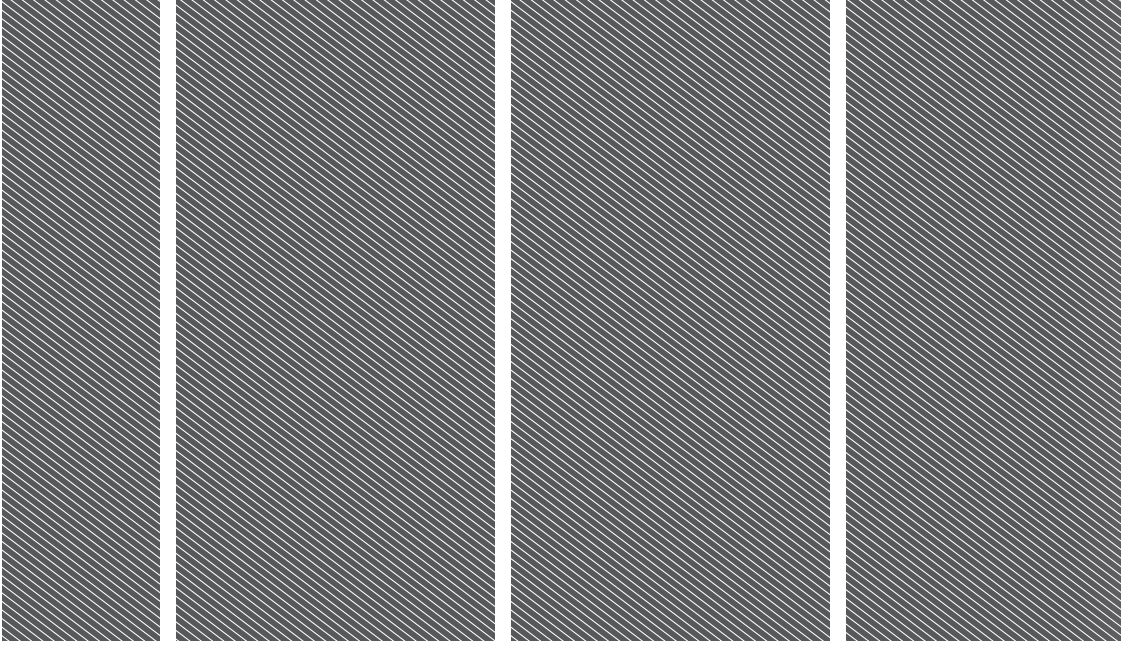

Techtronic Industries GmbH

Max-Eyth-Straße 10,
71364 Winnenden, Germany

Techtronic Industries (UK) Ltd

Fieldhouse Lane
Marlow Bucks SL7 1HZ
UK

961478263-01

