

A) 6mm
 B) 12mm
 C) 6mm
 D) 4.5mm
 E) 6mm

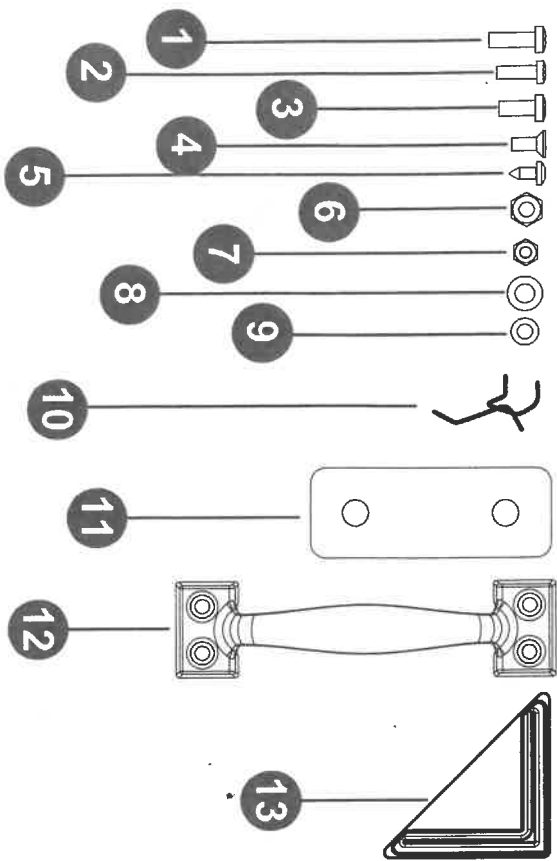

- 1) M6x14 mm (x8)
- 2) M4x12 mm (x10)
- 3) M6x10 mm (x63)
- 4) M4x10 mm (x8)
- 5) (x4)
- 6) M6 (x71)
- 7) M4 (x18)
- 8) M6 (x71)
- 9) M4 (x18)
- 10) (x30)
- 11) (x1)
- 12) (x2)
- 13) (x4)

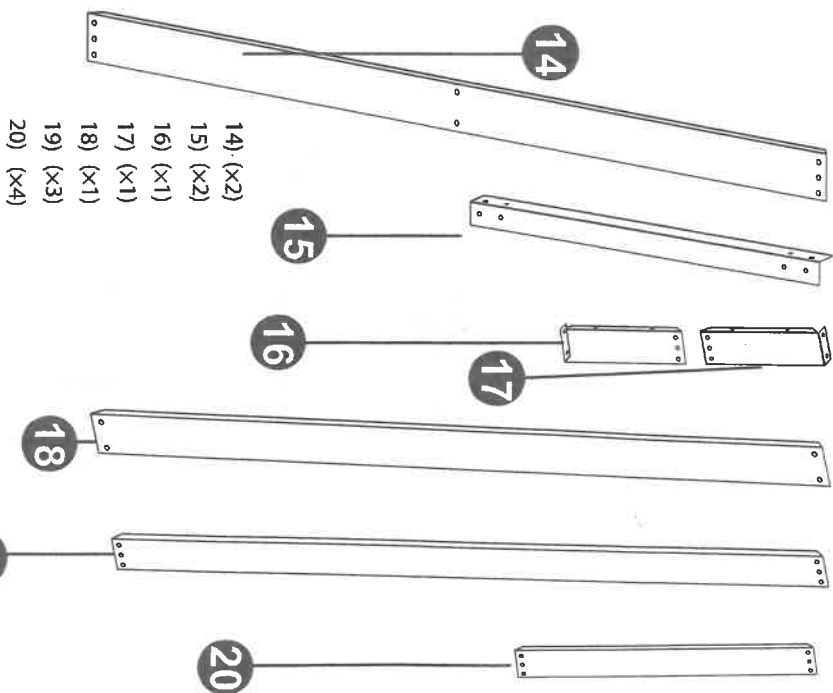

- 14) (x2)
- 15) (x2)
- 16) (x1)
- 17) (x1)
- 18) (x1)
- 19) (x3)
- 20) (x4)

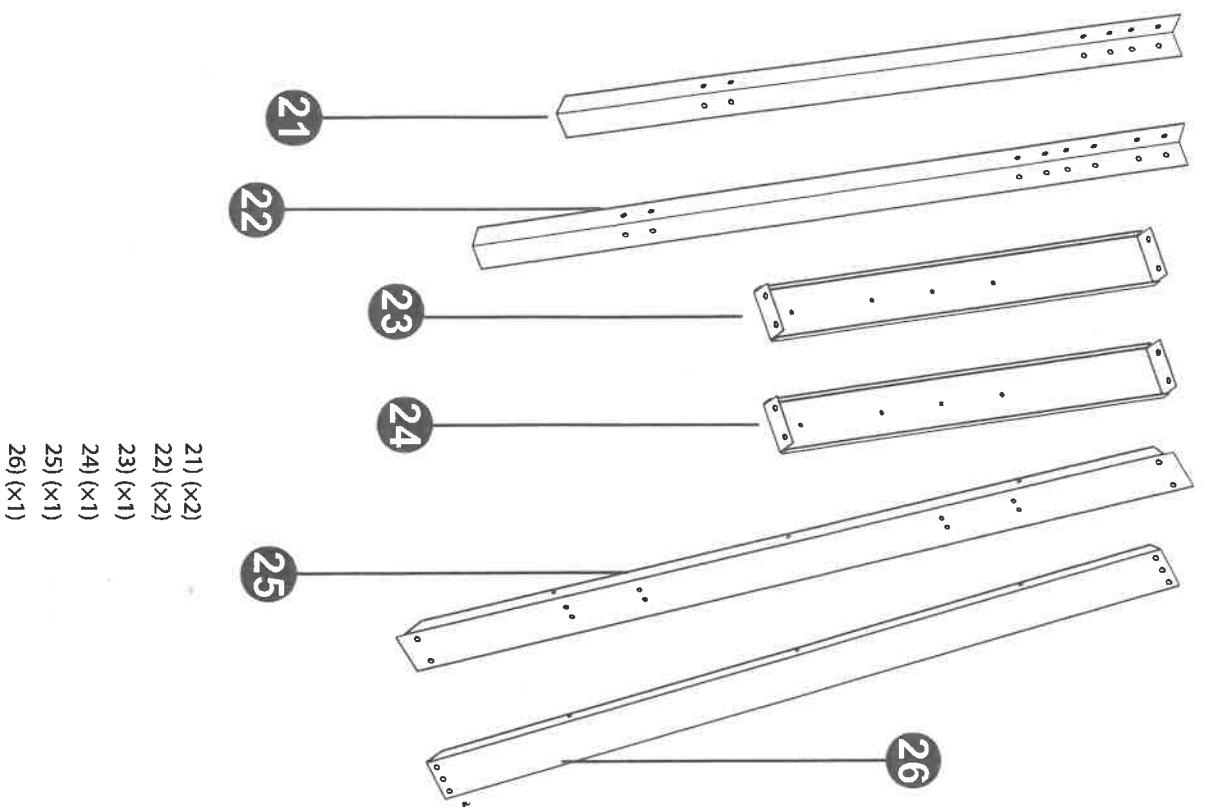

- 21) (x2)
- 22) (x2)
- 23) (x1)
- 24) (x1)
- 25) (x1)
- 26) (x1)

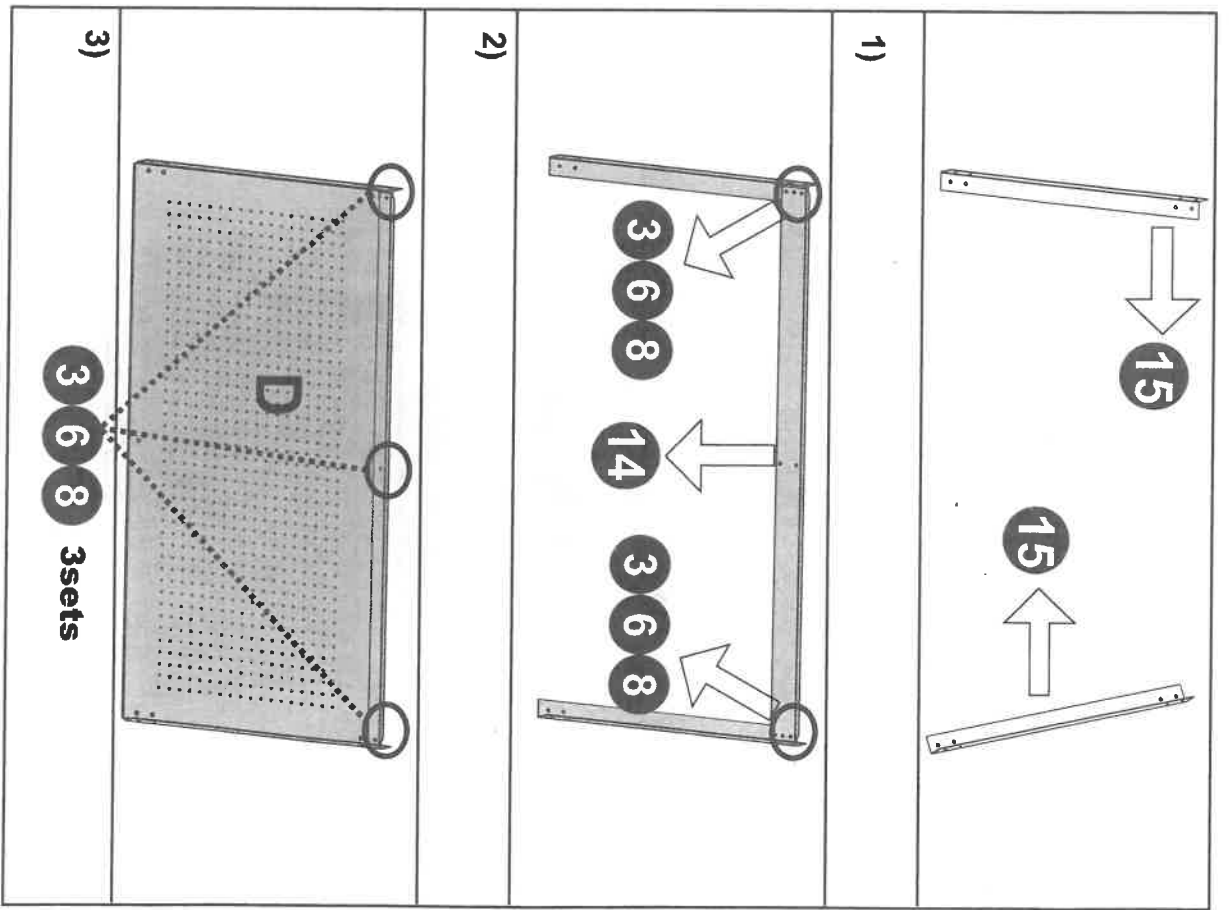

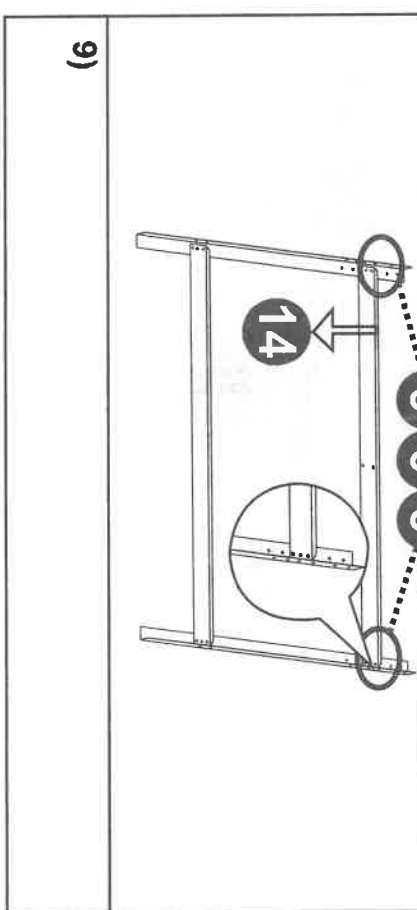
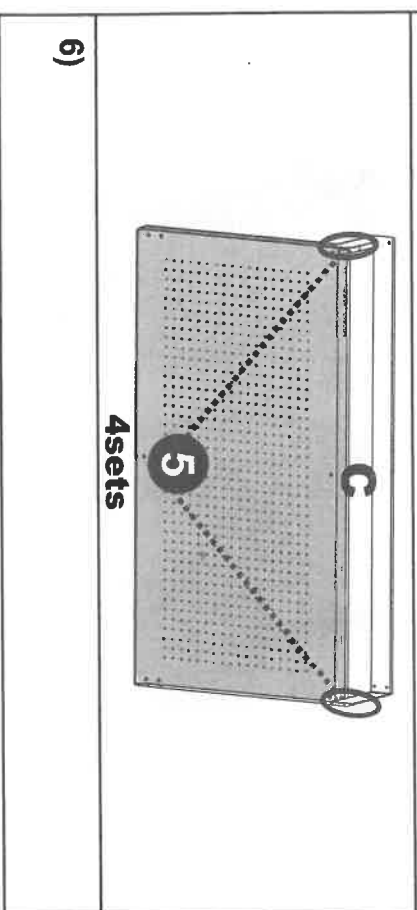
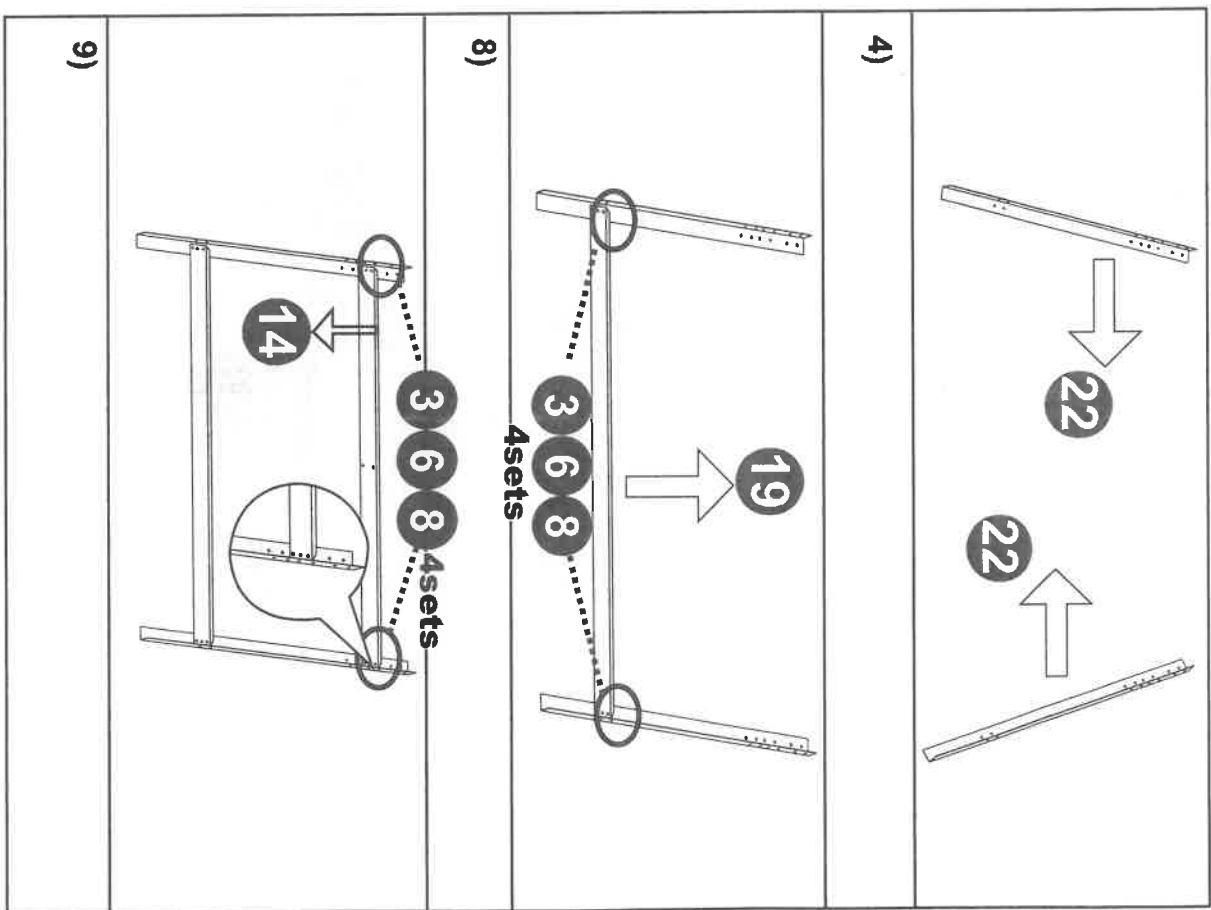
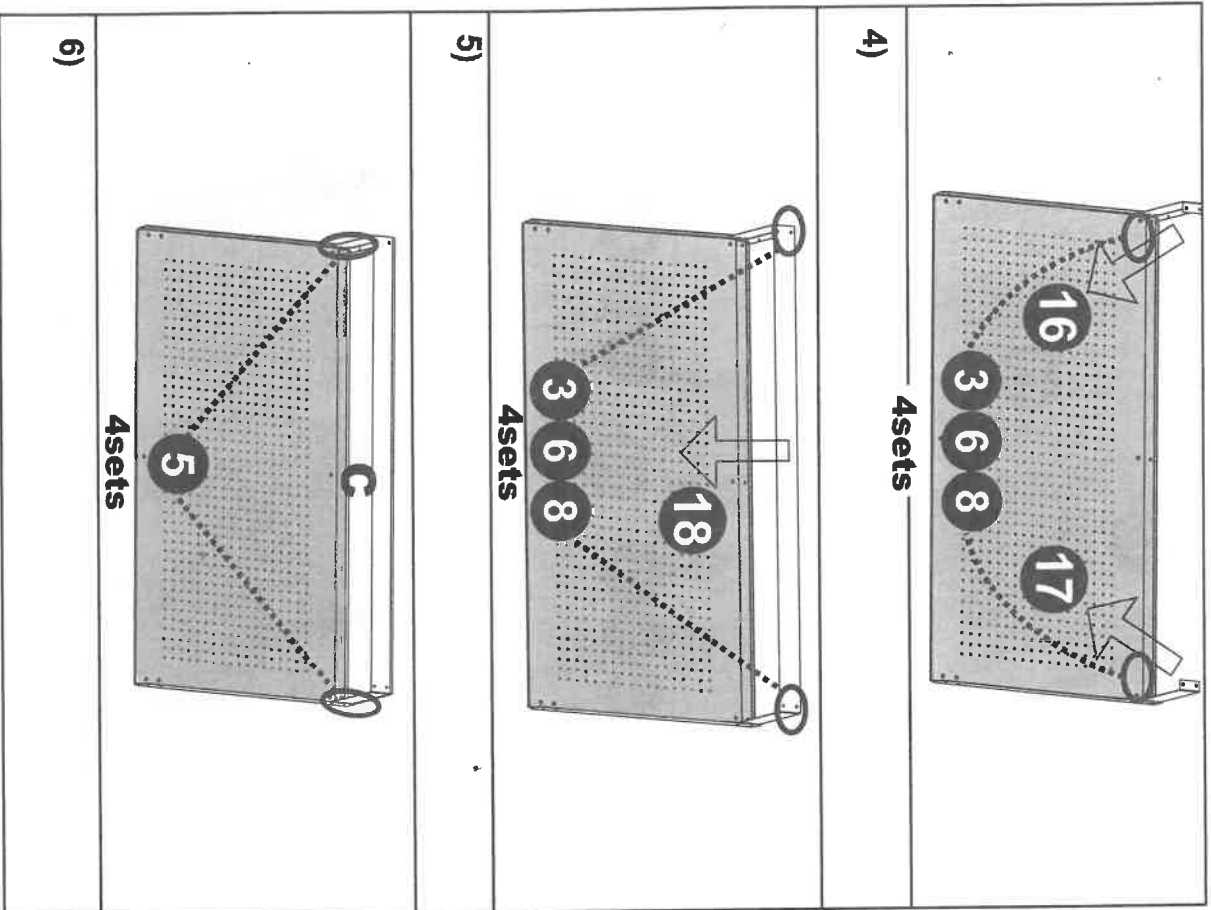

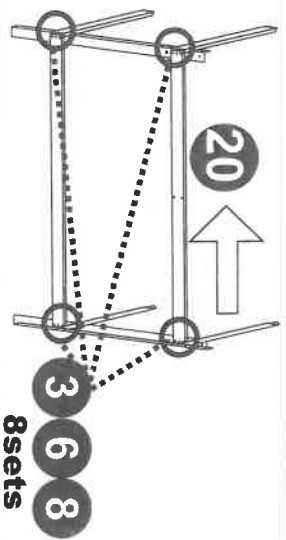

10)

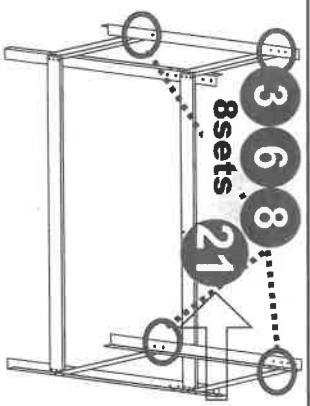

11)

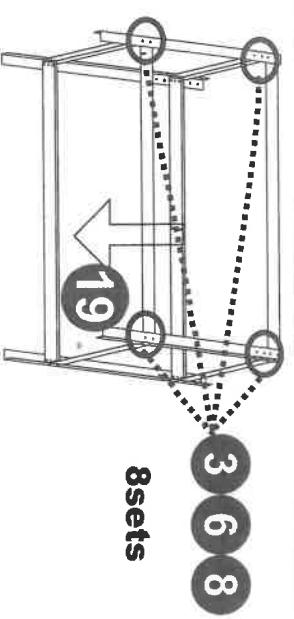

12)

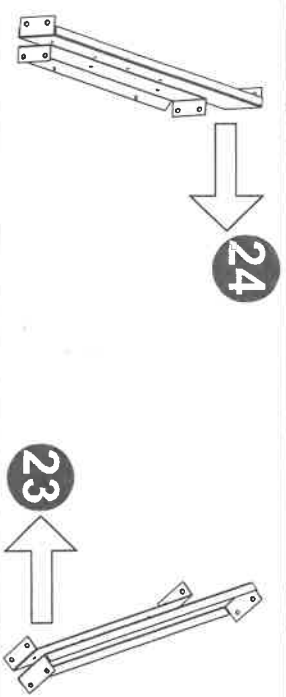

13)

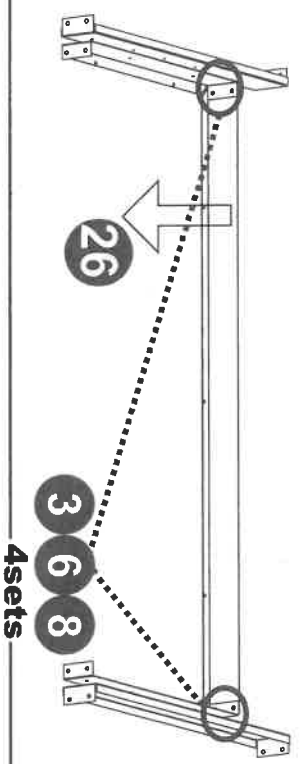

14)

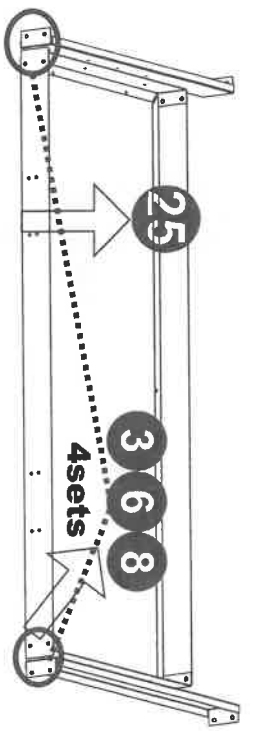

15)

