

EAN : 3276007811988

Adeo key : 91242399

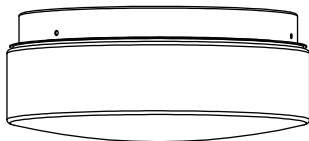

2/2



2024-05-V01

FR - Manuel d'Instructions
ES - Manual de Instrucciones
PT - Manual de Instruções
IT - Manuale di Istruzioni
EL - Εγχειρίδιο Οδηγιών
PL - Instrukcja Obsługi

UA - Інструкція з Експлуатації
RO - Manual de Instrucțiuni
BR - Manual de Instrução
NL - Handleiding
DE - Anleitung Handbuch
EN - Instructions Manual

*Année de garantie / años de garantía / Ano de garantia / Anno di garanzia / Έτος εγγύησης / Rok gwarancji / Гарантія років / Anul de garanție / Anos de garantía / Garantiejaar / Jahr der Garantie / Year of guarantee

** réparable / reparable / reparável / riparabile / διορθώσιμος / naprawiany / ремонтний / reparabil / reparaturfähig / reparável / herstelbaar / reparierbar / repairable



FR : assemblage / **ES :** ensamblaje / **PT :** montagem / **IT :** assemblaggio /
EL : συναρμολόγηση / **PL :** montaż / **UA :** збірка / **RO :** asamblare /
BR : montagem / **NE :** samenstelling / **DE :** Montage / **EN :** assembly



FR : Utilisation / **ES :** Uso / **PT :** Utilização / **IT :** Utilizzo
EL : Χρήση / **PL :** Użycie / **UA :** Використання / **RO :** Utilizare /
BR : Utilização / **NE :** Gebruik / **DE :** Verwendung / **EN :** Use

FR : CARACTÉRISTIQUES TECHNIQUES / **ES :** CARACTERÍSTICAS TÉCNICAS /
PT : CARACTERÍSTICAS TÉCNICAS / **IT :** CARATTERISTICHE TECNICHE / **EL :** ΤΕΧΝΙΚΑ
ΧΑΡΑΚΤΗΡΙΣΤΙΚΑ / **PL :** CECHY TECHNICZNE / **UA :** ТЕХНІЧНІ ХАРАКТЕРИСТИКИ /
RO : CARACTERISTICI TEHNICE / **BR :** CARACTERÍSTICAS TÉCNICAS / **NE :** TECHNISCHE KENMERKEN
/ **DE :** TECHNISCHE MERKMALE / **EN :** TECHNICAL SPECIFICATIONS

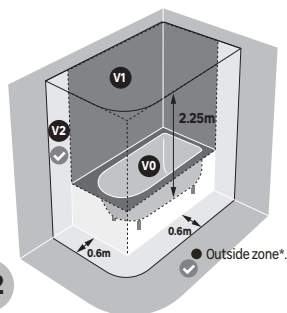

FR : *Hors volume.- **ES :** *Fuera del volumen.- **PT :** *Fora do volume.
- **IT :** *Fuori volume.- **UA :** *Вільний простір.- **PL :** *Wolna przestrze
- **EL :** *Εκτός όγκου.- **RO :** *Zona exteriora.- **BR :** *Fora do volume.-
NE : *Buitenzone- **DE :** *Außenbereich.

Dans le cas de locaux d'habitation, de locaux recevant une baignoire ou une douche et des prises de courant inférieures ou égales à 32A, le circuit correspondant doit être protégé par un disjoncteur différentiel (RCD) inférieur ou égal à 30 mA.

In the case of residential premises, premises receiving a bathtub or shower and power sockets less than or equal to 32A, the corresponding circuit must be protected by a differential-residual current device (RCD) less than or equal to 30 mA.

For installation in rooms containing bathtubs or showers, it shall be done by a qualified person to ensure the compliance of local regulations.

Pour l'installation dans des pièces contenant des baignoires ou des douches, elle doit être effectuée par une personne qualifiée afin de garantir le respect des réglementations locales.



A x1

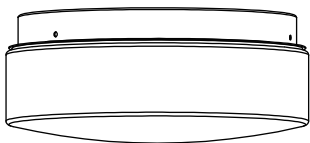

B  x2

C  x1

 x3

D



F
x3

 x3

E



∅ 6mm



PZ



E27 LED 12W Max

∅ 60mm



Max 110 mm



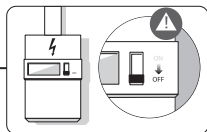

1

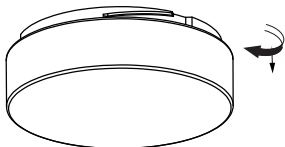
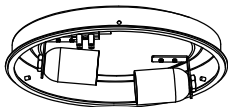

2

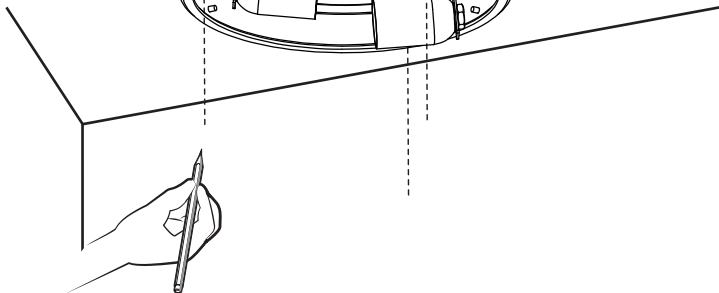
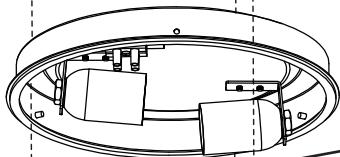

3

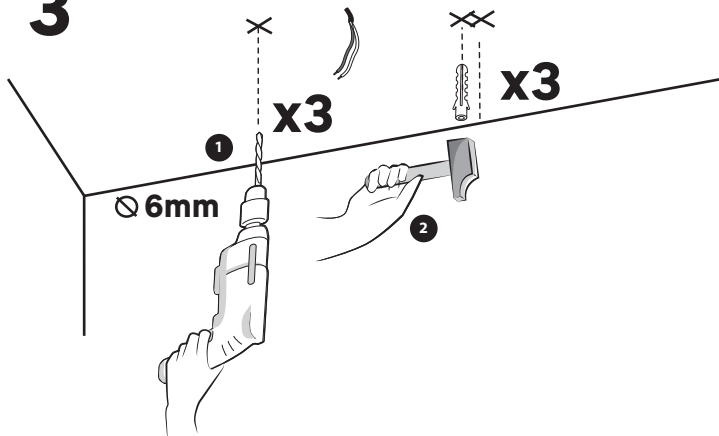

4

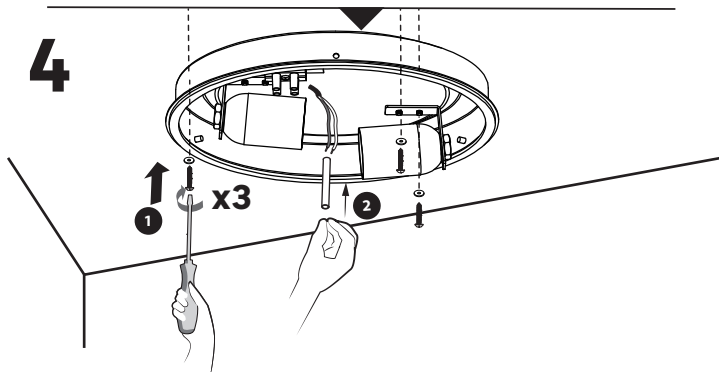

FR - Utiliser des vis et des chevilles adaptées à votre support. / **ES** - Utilice tacos y tornillos adecuados al soporte. / **PT** - Utilize buchas e parafusos adequado ao seu suporte. / **IT** - Utilizzare viti e tasselli adatti per il retro. / **GR** - Χρησιμοποιήστε βίδες και βύσματα που ταιριάζουν στην επιφάνεια στήριξης. / **PL** - Należy użyć śrub i kotków odpowiednich dla podłoża. / **UA** - Використовуйте гвинти та шканти, призначені для задньої поверхні. / **RO** - Utilizați șuruburi și dibluri adecvate pentru suportul dvs. / **BR** - Use parafusos e buchas adequados para seu suporte. / **NL** - Gebruik schroeven en pluggen die geschikt zijn voor uw ondergrond. / **DE** - Verwenden Sie für Ihre Unterlage geeignete Schrauben und Dübel. / **EN** - Use screws and dowels suited to your backing.

5

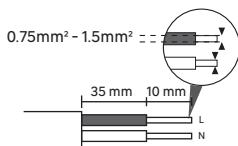
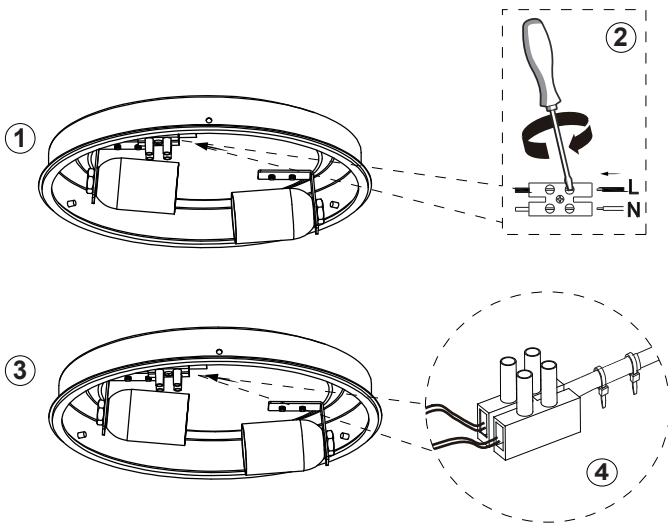

N = Bleu/Azul/Azul/Blu/Μπλε/Niebieski/Синій/Albastru/ Blauw/Blau/**Blue**

L = Marron/Marrón/Castanho/Marrone/Κοφέ/Βραζowy/
Коричневий/Μαρο/Marrom/bruin/Braun/**Brown**

6

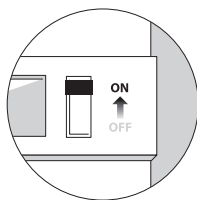
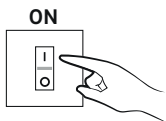
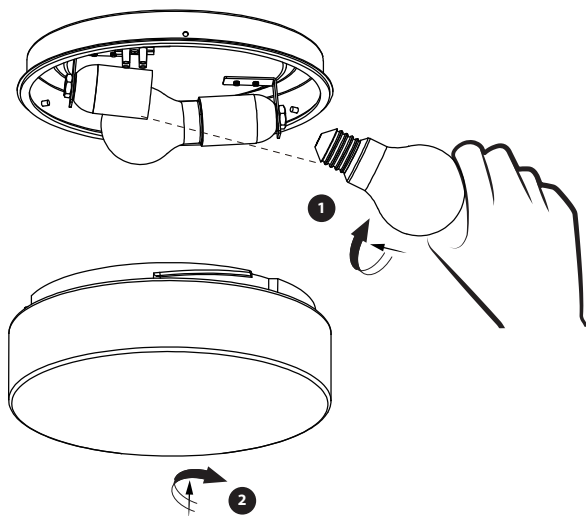



Made in China
Країна походження: Китай

EU - ADEO Services - 135 Rue Sadi Carnot - CS00001 - 59790 RONCHIN - FRANCE
www.product-regulatory.adeoservices.com

UA Виробник: ТОВ "Адео Сервісез С.А.", вул. Саді Карно, CS 00001, 59790 Роншен, Франція.
Імпортер: ТОВ "Леруа Мерлен Україна", 04201 Україна, м. Київ, вул. Полярна 17А, +380 44 498 46 00. Імпортер приймає претензії від споживачів щодо товару, а також проводить його ремонт, технічне і гарантійне обслуговування

BR LEROY MERLIN COMPANHIA BRASILEIRA DE BRICOLAGEM
CNPJ: 01.438.784/0001-05
Rua Pascoal Pais, nº. 525, 6º andar cj 61 a 64, Vila Cordeiro, São Paulo -SP. CEP: 04581-060
CALM (Central de Atendimento Leroy Merlin) Capitais
4020-5376 Demais Regiões 0800-0205376

ZA Imported by Adeo South Africa (PTY) LTD T/A Leroy Merlin, Hosted in Leroy Merlin Fourways Store 35 Roos Street, Witkoppen Ext 97, Sandton, 2191 Johannesburg, Gauteng, South Africa.
Tel: +27 10 493 8000 Email: contact@leroymerlin.co.za.

