

# ESSENTIAL

- FR** Nous vous remercions d'avoir acheté ce produit. Nous vous conseillons de lire attentivement la notice d'installation, d'utilisation et d'entretien. Nous avons conçu ce produit pour vous apporter entière satisfaction. Si vous avez besoin d'aide l'équipe de votre magasin est à votre disposition pour vous accompagner.
- ES** Le agradecemos haber comprado este producto. Le recomendamos leer atentamente el manual de instalación, uso y mantenimiento. Este producto ha sido diseñado para proporcionarle plena satisfacción. Si necesita alguna ayuda, el personal de la tienda estará a su disposición para guiarle.
- PT** Agradecemos a sua preferência por este produto . Aconselhamo-lo a ler o manual de instalação , utilização e manutenção com atenção. Criámos este produto para sua completa satisfação. Se precisar de ajuda, a equipa da sua loja está à sua disposição para o acompanhar.
- IT** Grazie per aver acquistato questo prodotto. Vi raccomandiamo di leggere attentamente il manuale di installazione, utilizzo e manutenzione. Questo prodotto è stato progettato per offrirvi la massima soddisfazione. Per ricevere assistenza, il personale del punto vendita è a vostra disposizione.
- EL** μ μ μ μ μ
- PL** Dziękujemy za zakup produktu firmy. Zalecamy, aby uważnie przeczytać instrukcję instalacji, użytkowania i konserwacji. Ten produkt marki zaprojektowaliśmy, aby spełnić wszystkie państwa oczekiwania. W razie potrzeby pracownicy sklepu służą Państwu pomocą i są do Państwa dyspozycji.
- UA**
- RO** V mul umim pentru achiziționarea acestui produs . V sfatuim să citiți cu atenție instrucțiunile de instalare, de utilizare și de întreținere. Am conceput acest produs pentru a vă furniza satisfacție totală. Dacă aveți nevoie de ajutor, echipa magazinului de lângă dvs este la dispoziția dumneavoastră pentru a vă asista.
- BR** Obrigado por ter adquirido um produto . Nós aconselhamos a ler atentamente o manual de instalação, uso e manutenção. Concebemos um produto para proporcionar total satisfação. Caso precise de ajuda, a equipe da sua loja estará à disposição para te acompanhar.
- EN** Thank you for purchasing this product. We recommend that you read the installation, user and maintenance instructions carefully. We have designed this product to ensure your complete satisfaction. If you require assistance, the team at your retailer is on hand to help you.

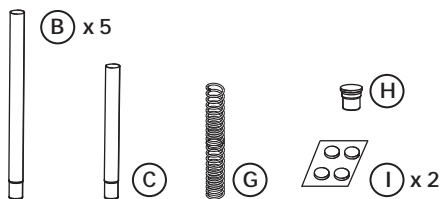

(i)

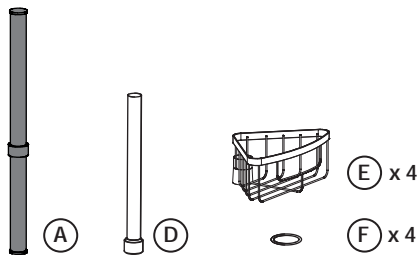
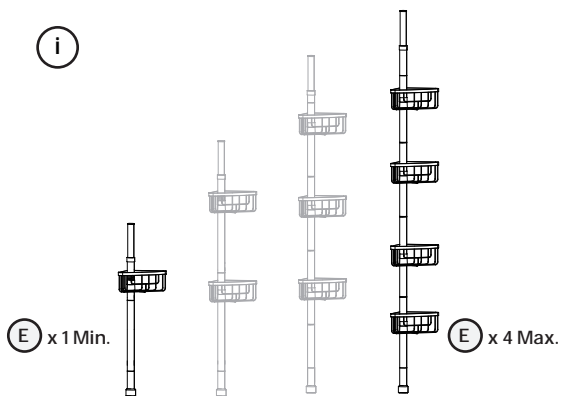

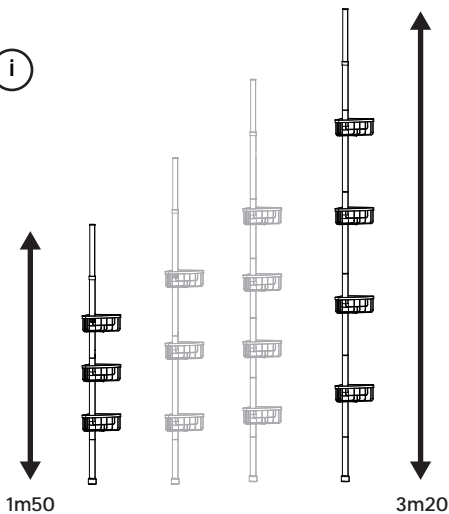

SIZE	OK or NOK	MATERIAL
<1m50	NOK	—————
1m50	OK	(A) + (B) x2 + (D)
1m80	OK	(A) + (B) x2 + (C) + (D)
2m	OK	(A) + (B) x3 + (D)
2m30	OK	(A) + (B) x3 + (C) + (D)
2m50	OK	(A) + (B) x4 + (D)
2m80	OK	(A) + (B) x4 + (C) + (D)
3m	OK	(A) + (B) x5 + (D)
3m20	OK	(A) + (B) x5 + (C) + (D)
>3m20	NOK	—————



1A

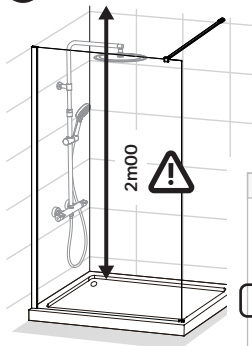

SIZE	MATERIAL
<1m50	—————
1m50	(A) + (B) x2 + (D)
1m80	(A) + (B) x2 + (C) + (D)
<b>2m</b>	<b>(A) + (B) x3 + (D)</b>
2m30	(A) + (B) x3 + (C) + (D)
2m50	(A) + (B) x4 + (D)
2m80	(A) + (B) x4 + (C) + (D)
3m	(A) + (B) x5 + (D)
3m20	(A) + (B) x5 + (C) + (D)
>3m20	—————

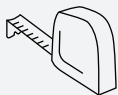

(A)



(B) x3



(D)



1B

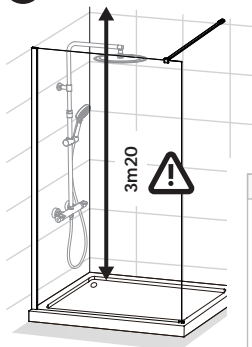

SIZE	MATERIAL
<1m50	—————
1m50	(A) + (B) x2 + (D)
1m80	(A) + (B) x2 + (C) + (D)
2m	(A) + (B) x3 + (D)
2m30	(A) + (B) x3 + (C) + (D)
2m50	(A) + (B) x4 + (D)
2m80	(A) + (B) x4 + (C) + (D)
3m	(A) + (B) x5 + (D)
<b>3m20</b>	<b>(A) + (B) x5 + (C) + (D)</b>
>3m20	—————

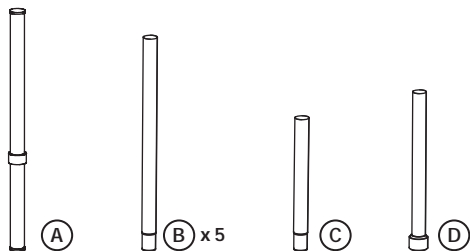
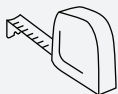



x1 Min. // x4 Max.



x2 Min. // x5 Max.



(optional)



x2

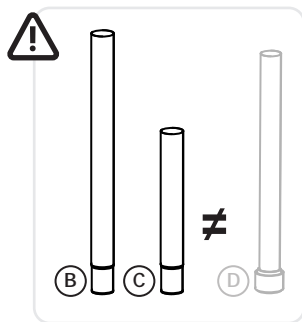
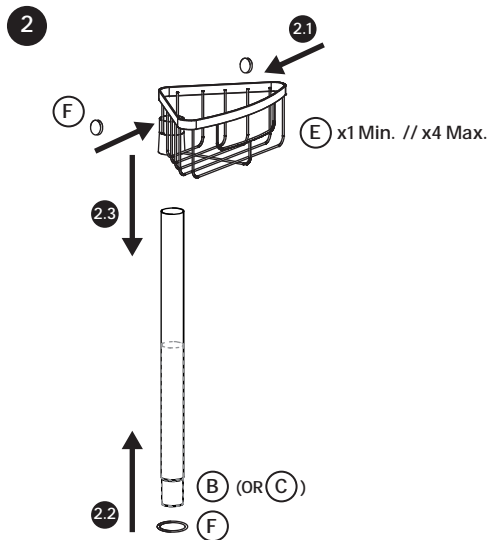



G



H

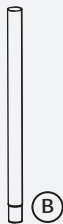

B

3



G

H

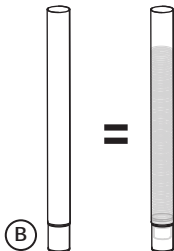

B

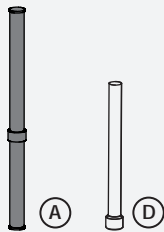

A

D

4

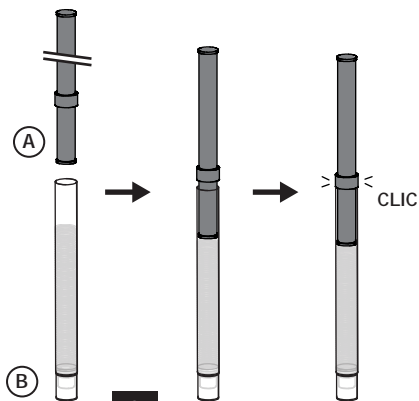

A

B

CLIC





5A

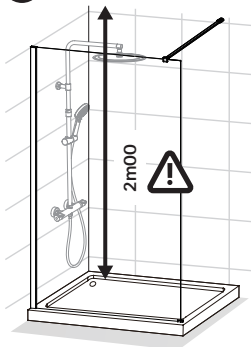

SIZE	MATERIAL
<1m50	—————
1m50	(A) + (B) x2 + (D)
1m80	(A) + (B) x2 + (C) + (D)
<b>2m</b>	<b>(A) + (B) x3 + (D)</b>
2m30	(A) + (B) x3 + (C) + (D)
2m50	(A) + (B) x4 + (D)
2m80	(A) + (B) x4 + (C) + (D)
3m	(A) + (B) x5 + (D)
3m20	(A) + (B) x5 + (C) + (D)
>3m20	—————

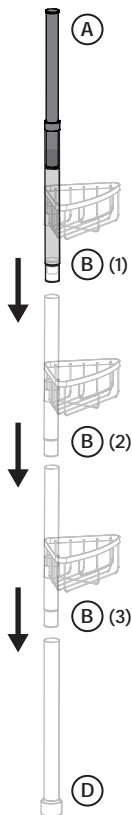



5B

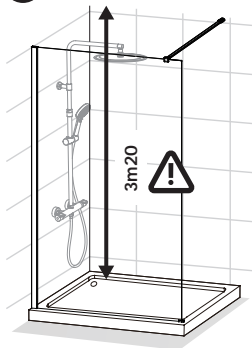

SIZE	MATERIAL
<1m50	—————
1m50	(A) + (B) x2 + (D)
1m80	(A) + (B) x2 + (C) + (D)
2m	(A) + (B) x3 + (D)
2m30	(A) + (B) x3 + (C) + (D)
2m50	(A) + (B) x4 + (D)
2m80	(A) + (B) x4 + (C) + (D)
3m	(A) + (B) x5 + (D)
<b>3m20</b>	<b>(A) + (B) x5 + (C) + (D)</b>
>3m20	—————

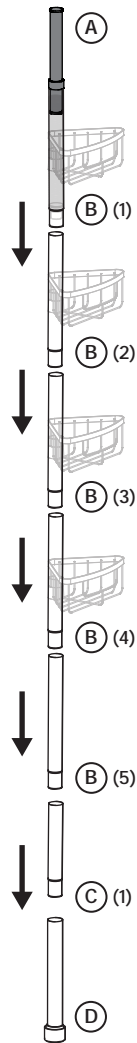

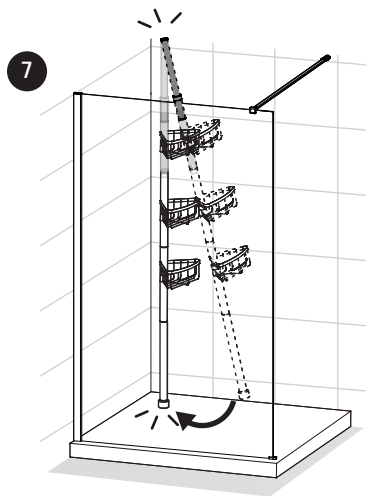
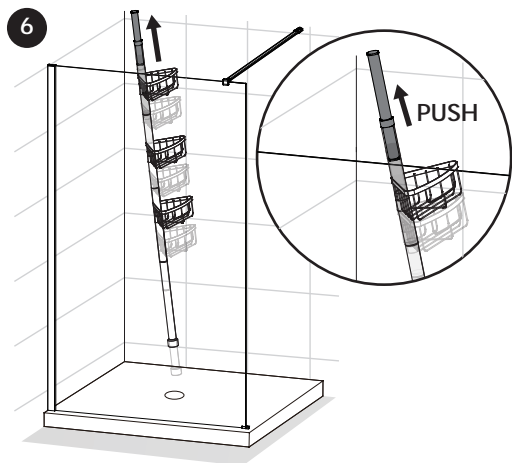



FR / País de Origem: China / Made in China

Garantie 5 ans / Garantía 5 años / Garantia 5 anos / Garanzia 5 anni  
/ E 5 / Gwarancja 5 lat / 10 / Garan ie 5  
ani / Garantia 5 anos / 5-year guarantee

ADEO Services - 135 rue Sadi Carnot - CS 00001.59790 RONCHIN – FRANCE  
www.product-regulatory.adeoservices.com

S 00001,59790

17 , +380 44 498 46 00.

04201

Importado e distribuído por LEROY MERLIN COMPANHIA BRASILEIRA DE  
BRICOLAGEM CNPJ: 01.438.784/0001-05. Rua Pascoal Pais, nº. 525, 6º  
andar cj 61 a 64, Vila Cordeiro, São Paulo - SP. CEP: 04581-060  
CALM (Central de Atendimento Leroy Merlin) Capitais 4020-5376 Demais  
Regiões 0800-0205376

Imported by Adeo South Africa (PTY) LTD T/A Leroy Merlin,  
Hosted in Leroy Merlin Fourways Store 35 Roos Street, Witkoppen Ext  
97, Sandton, 2191 Johannesburg, Gauteng, South Africa. Tel: +27 10 493  
8000 Email: contact@leroymerlin.co.za

**IMPORTANT**, à  
conserver pour  
consultation ultérieure:  
à lire attentivement

**IMPORTANTE**,  
conservar para consultar  
posteriormente:  
leer atentamente

**IMPORTANTE**,  
conservar para futuras  
consultas: por favor,  
leia com atenção

**IMPORTANTE**,  
da conservare per  
ulteriore consultazione:  
da leggere attentamente

μ

**WA NE**,  
przeczyta uwa nie l  
zachowa na przyszło

**IMPORTANT**,  
a se pastra pentru  
consultarea  
ulterioara: citi i cu  
aten ie

**IMPORTANTE**,  
por favor manter este  
material para consultas  
futura, leia com atenção

**IMPORTANT**, to be  
retained for future  
reference: please  
read carefully